



**CNC\_LAB**

*Dokumentation SS`13*



## Inhalt:

- Unsere Gruppe
- Zielsetzung
- Anregungen
- Aufgabenstellung
- Umsetzung digital
- Negativform fräsen
- Positivform gießen
- Gipsmuster x4
- Einzelstück
- Zukunftsperspektive





Julia Borho



Lisa Mößner



Kristina Thiemann



Tobias Haasis

Unsere Gruppe





+



= ?

Zielsetzung



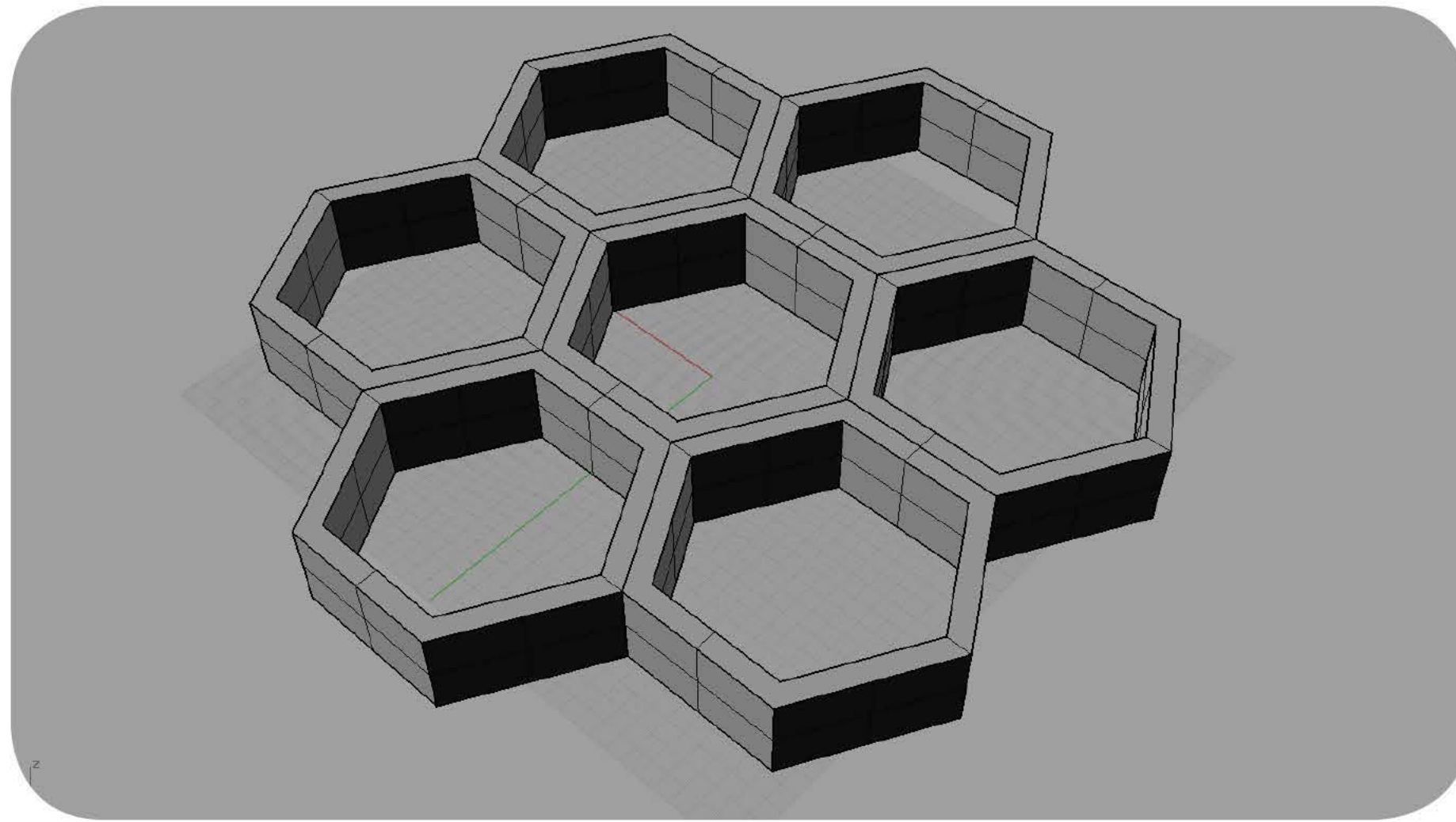
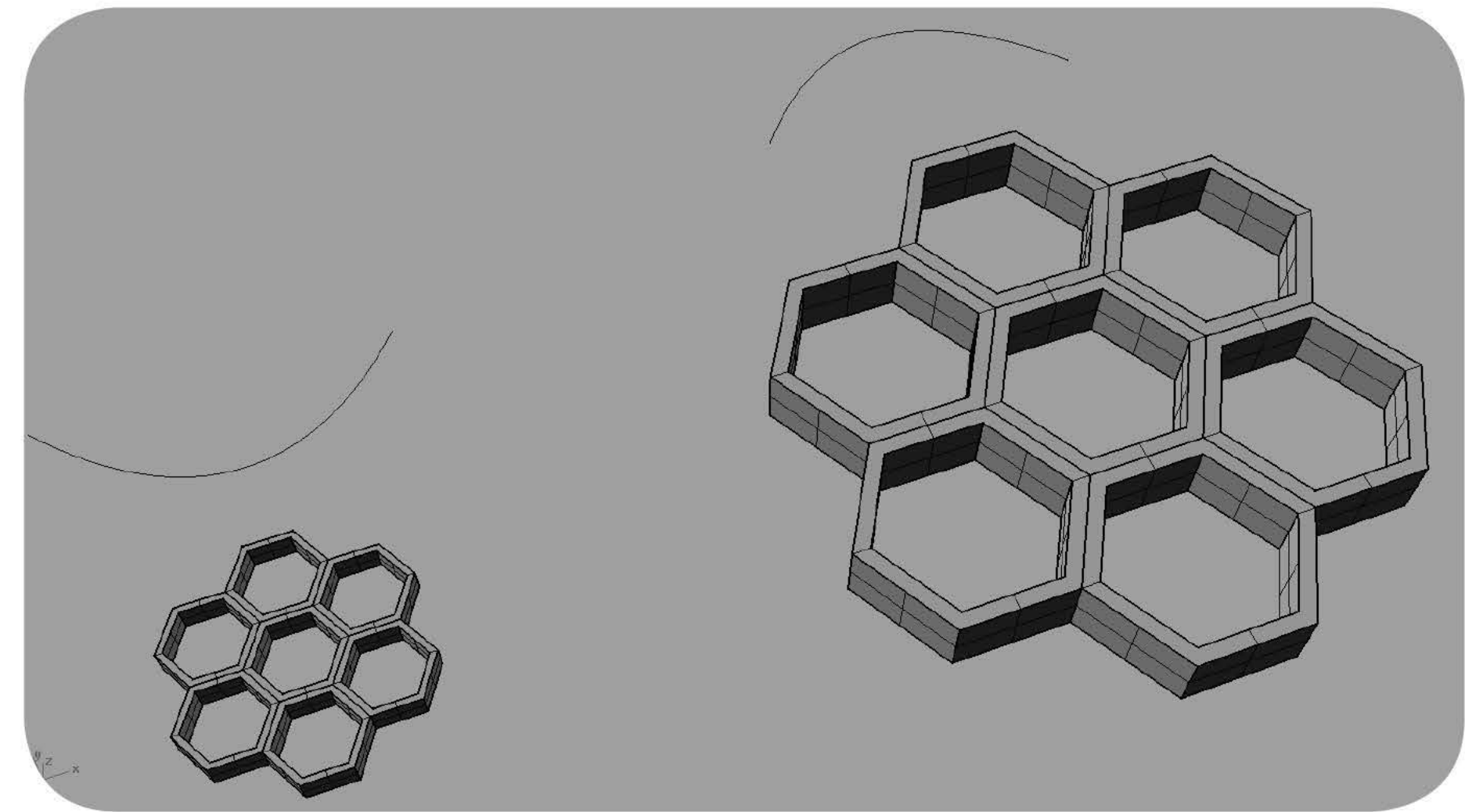
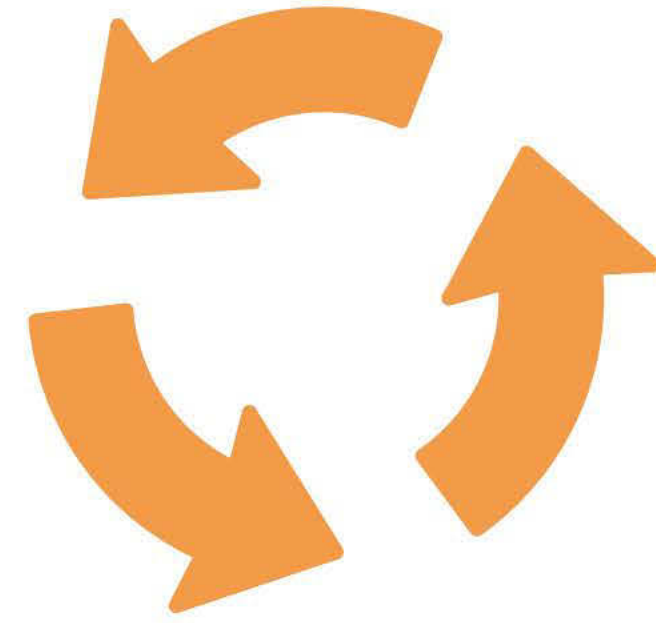
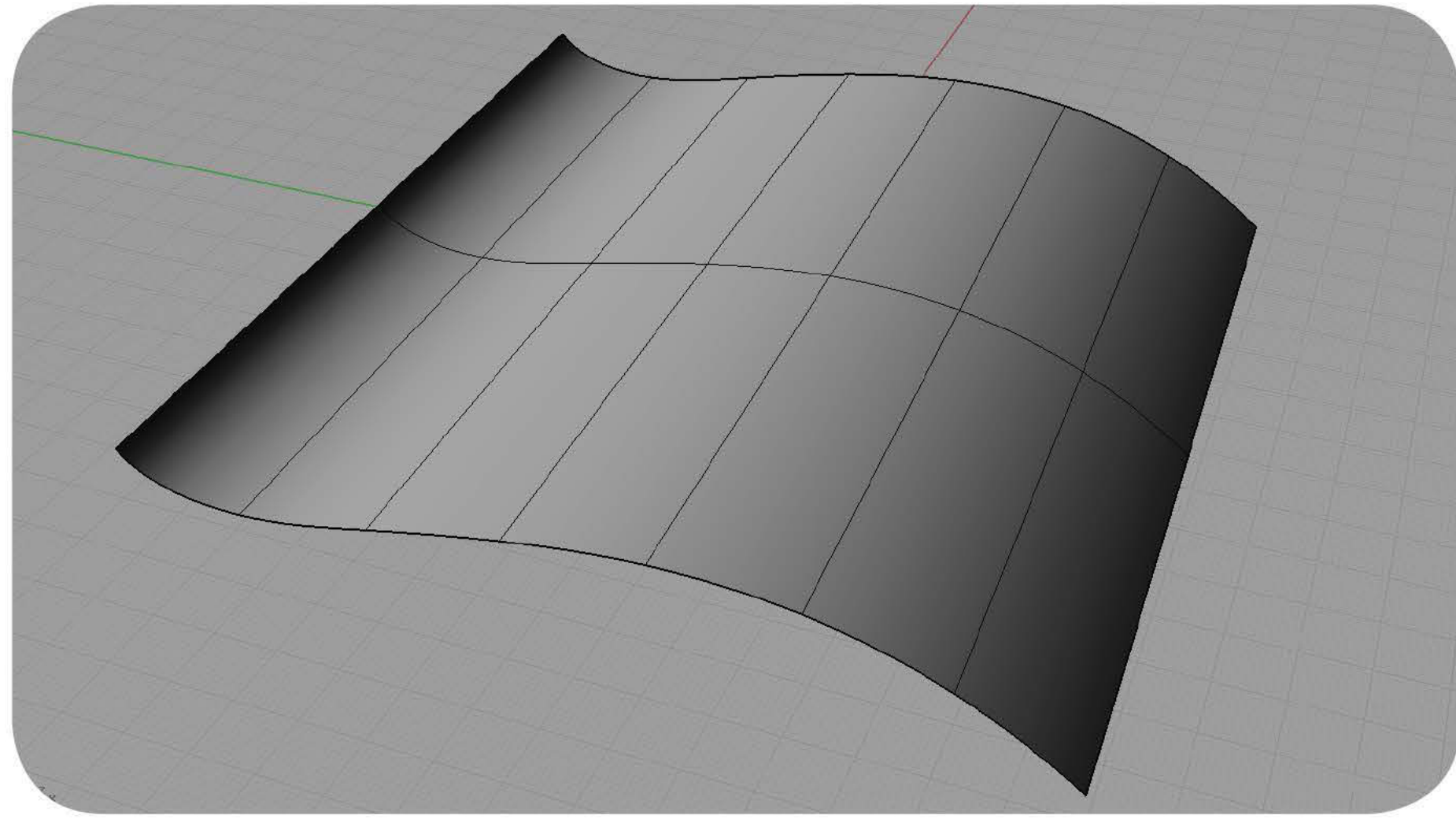

Aufgabenstellung



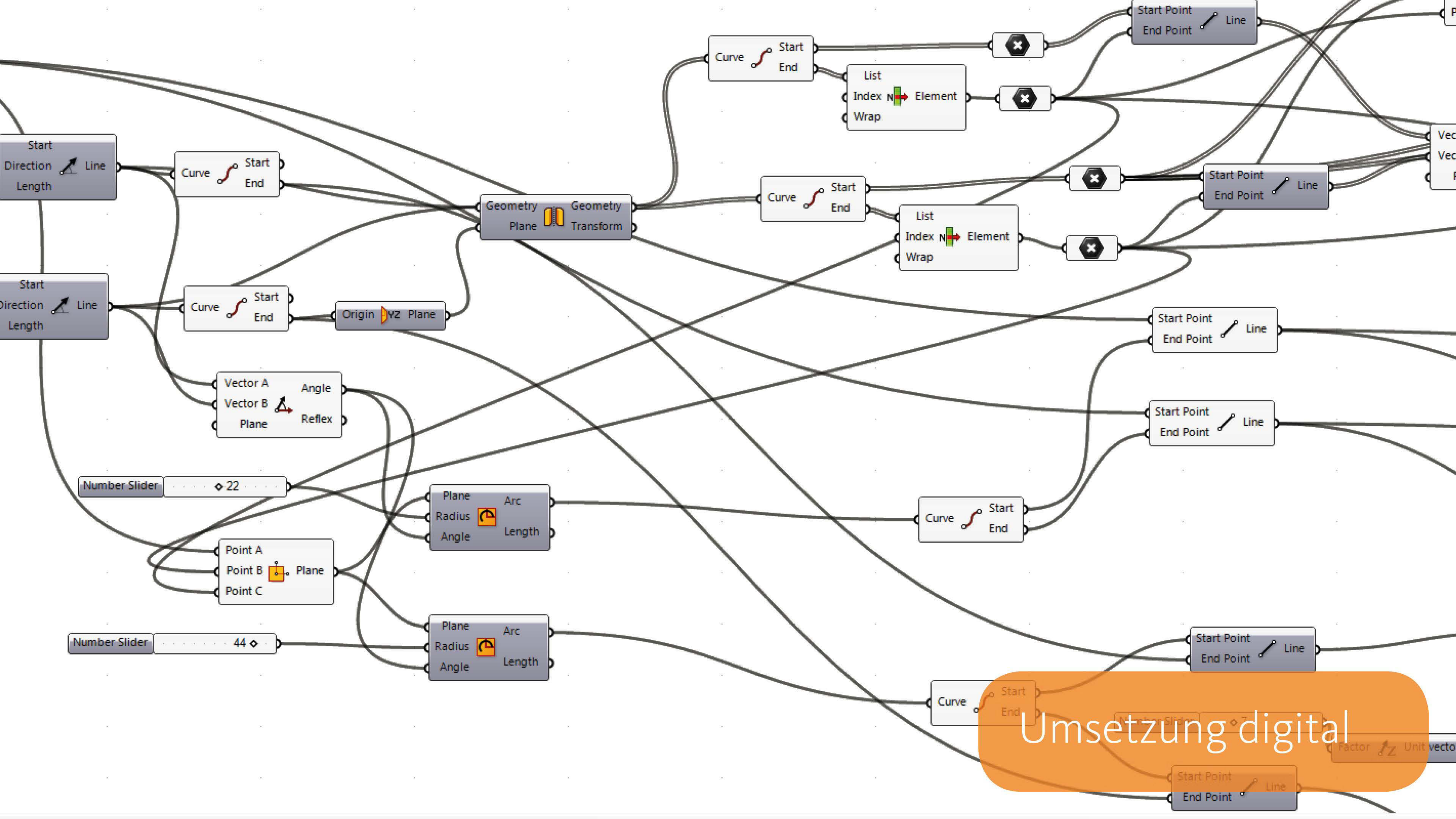

Umsetzung digital



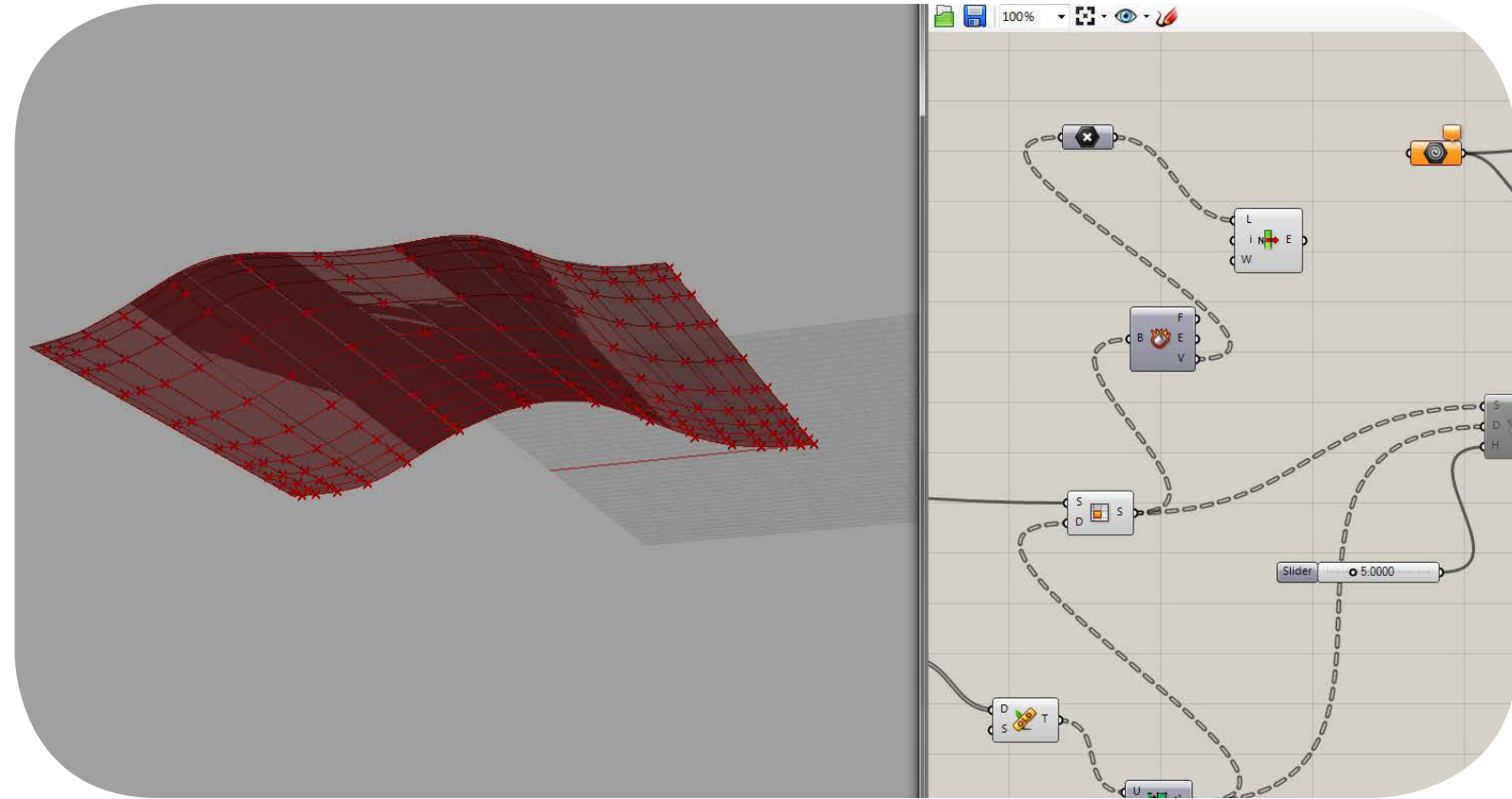
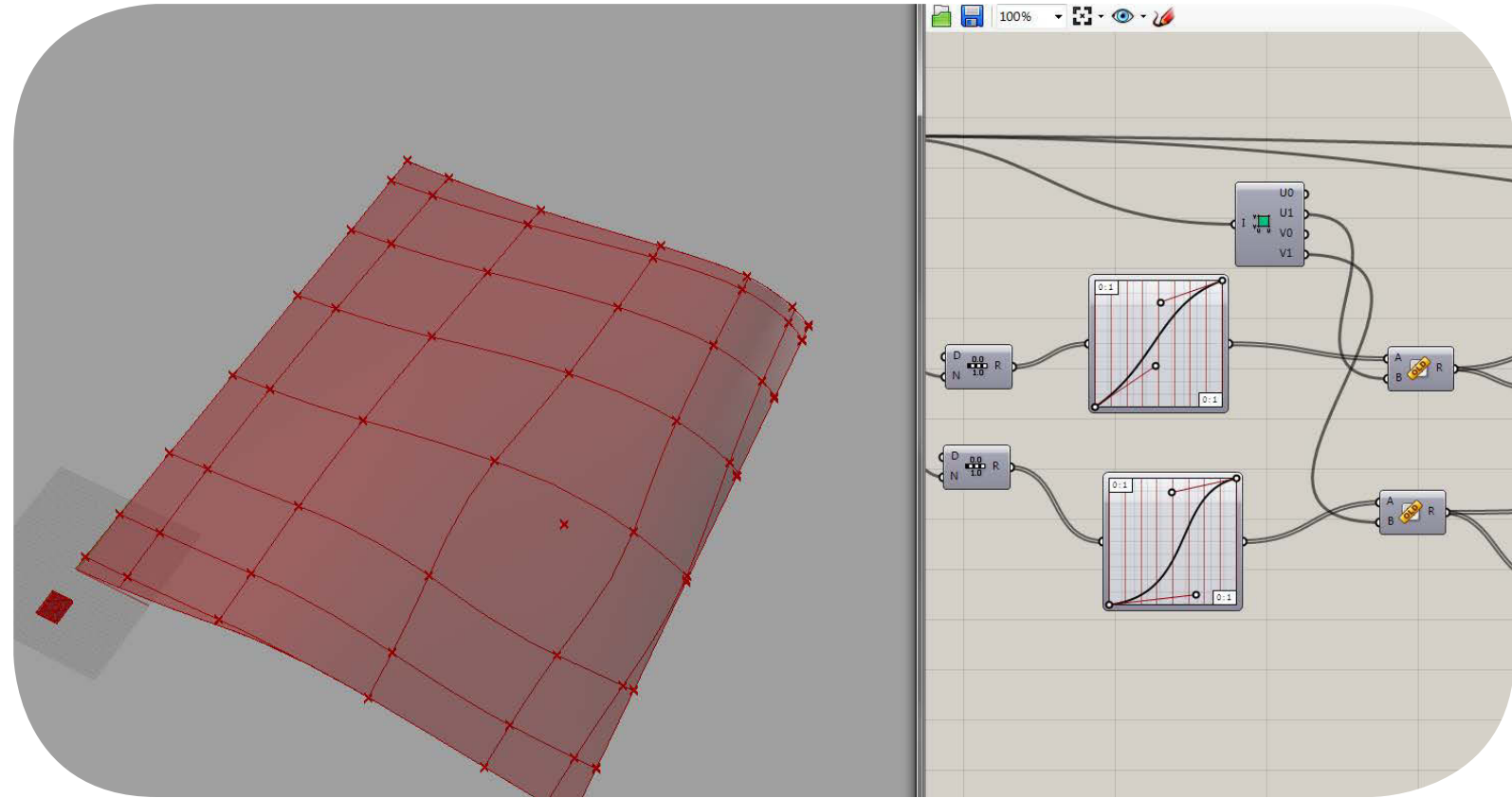
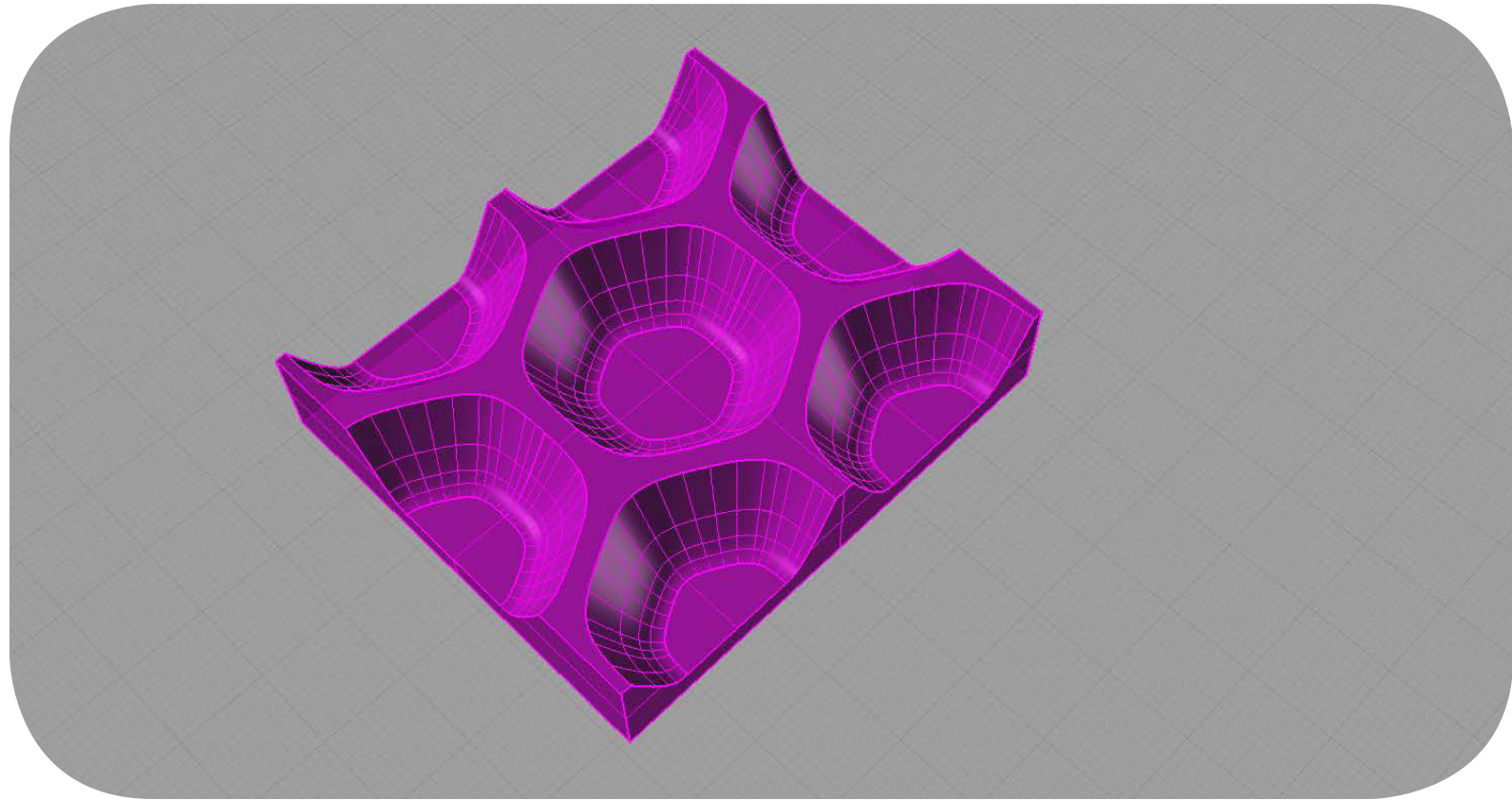
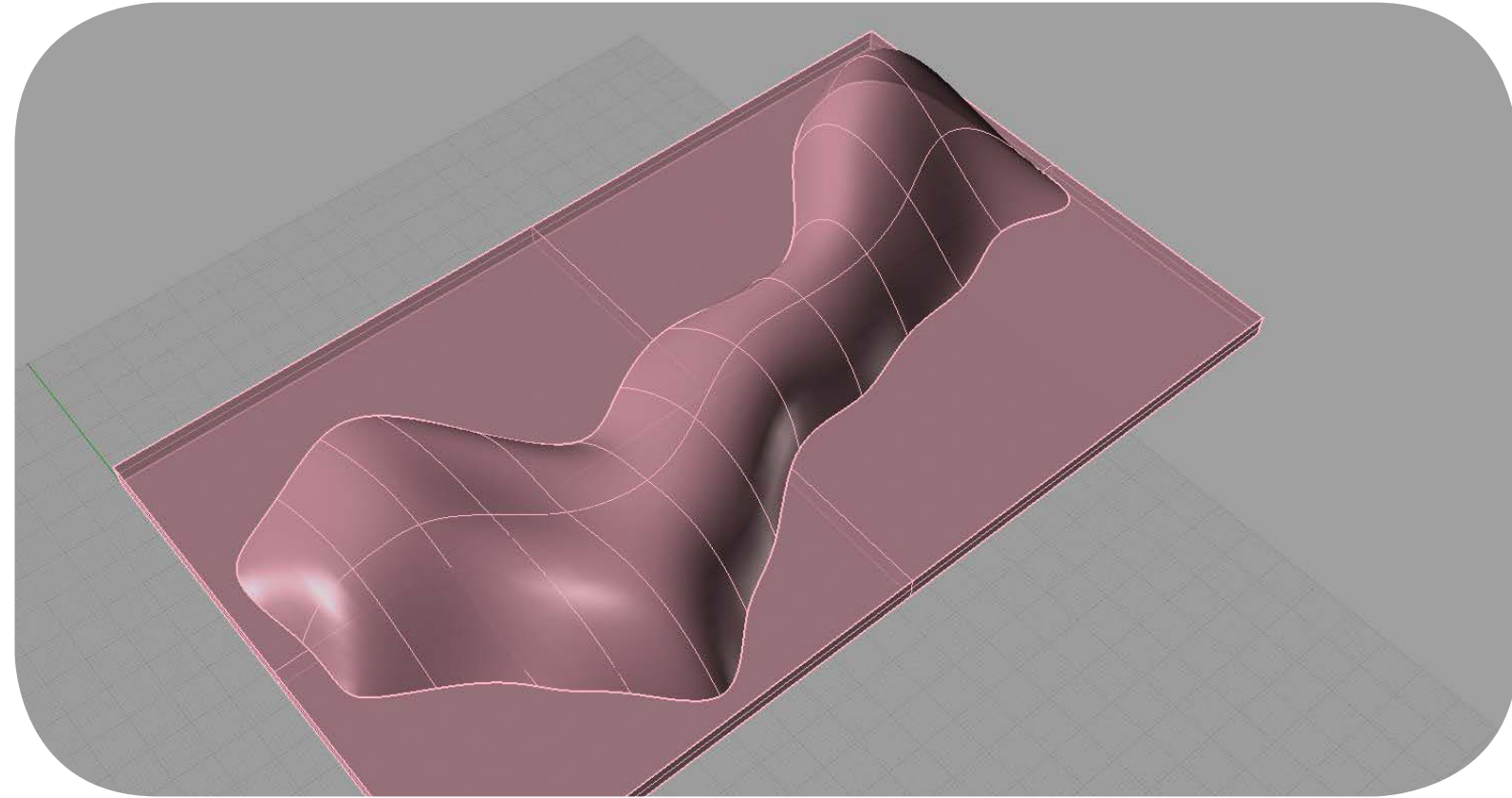
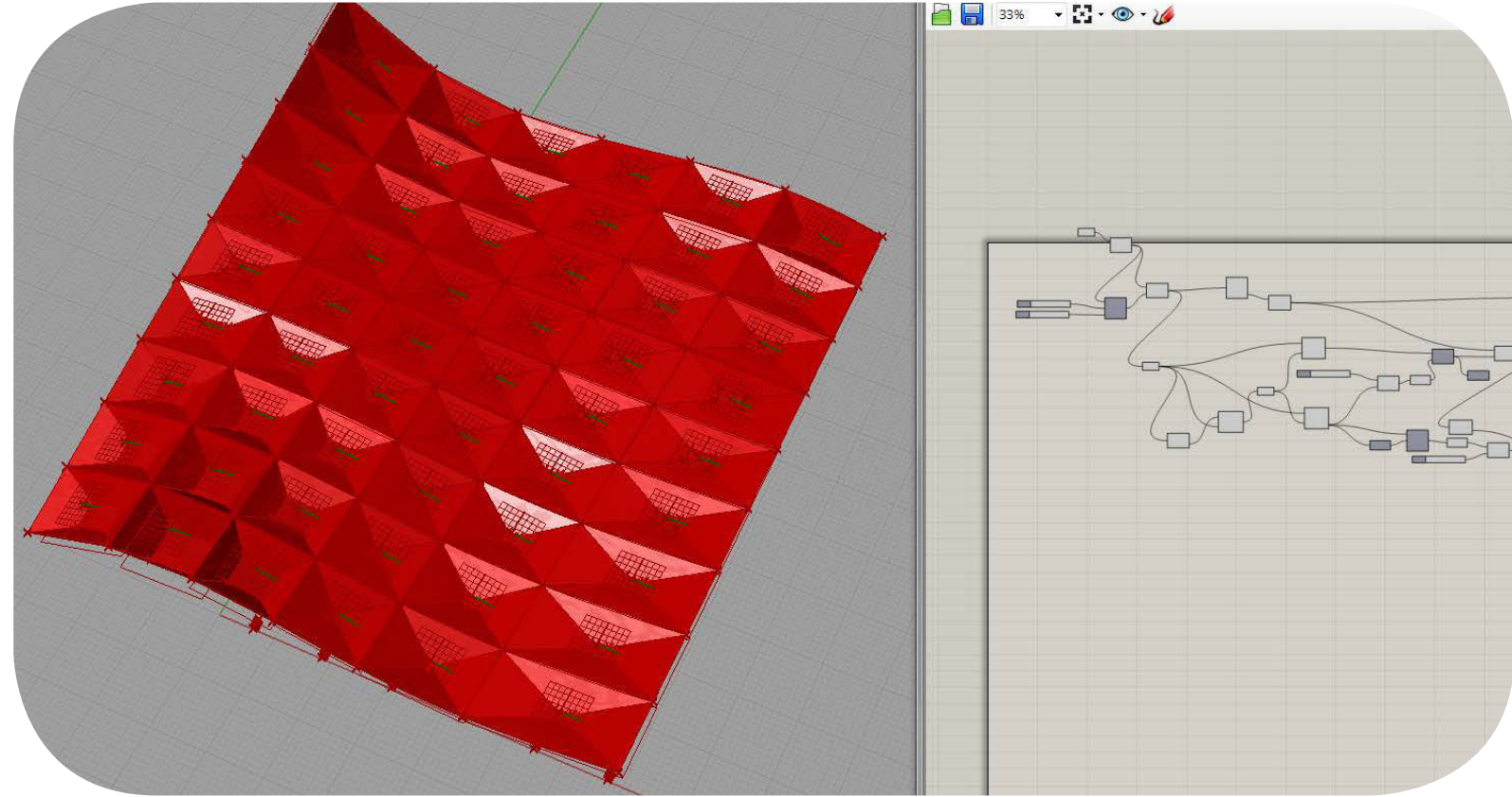
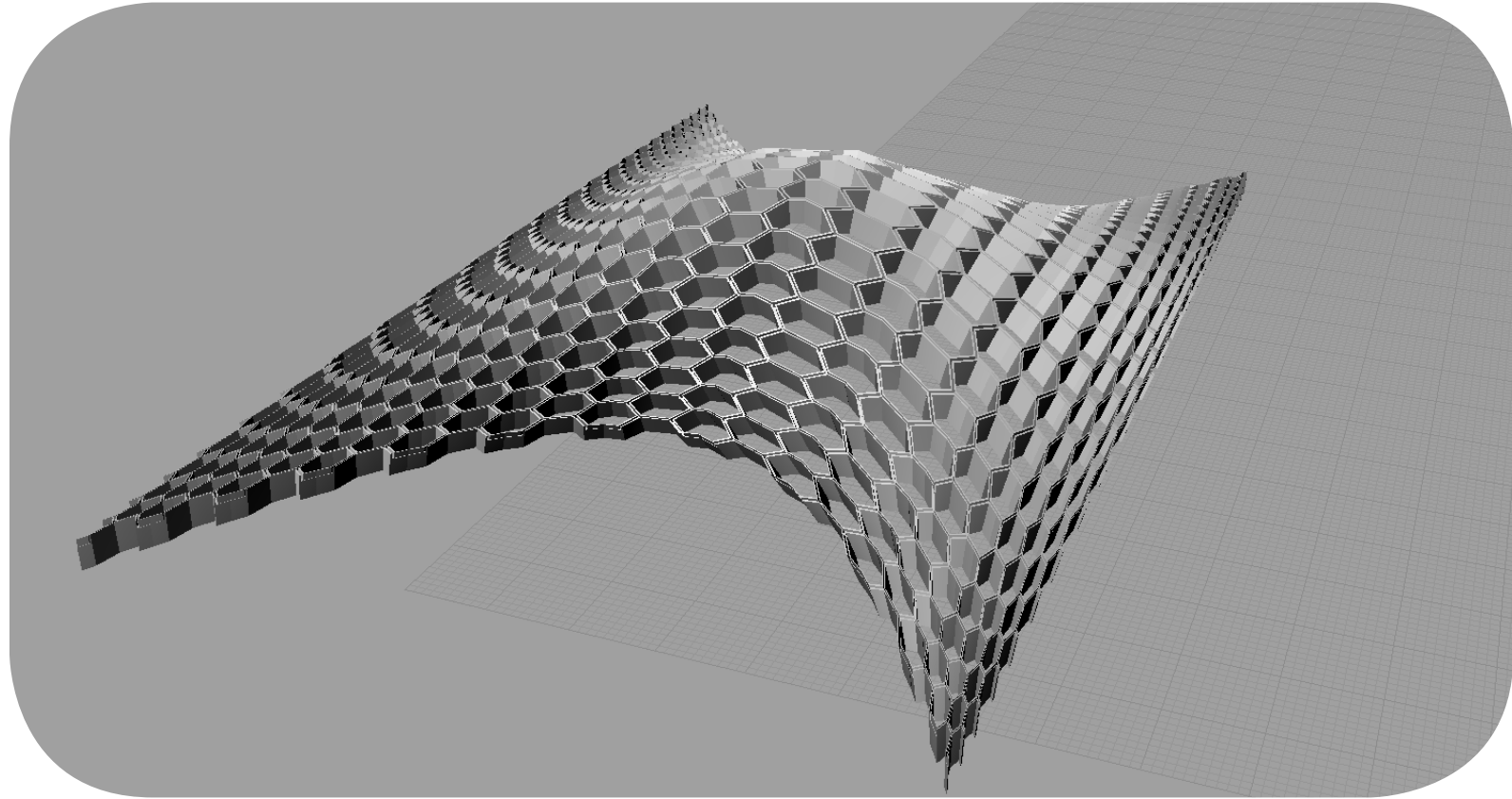
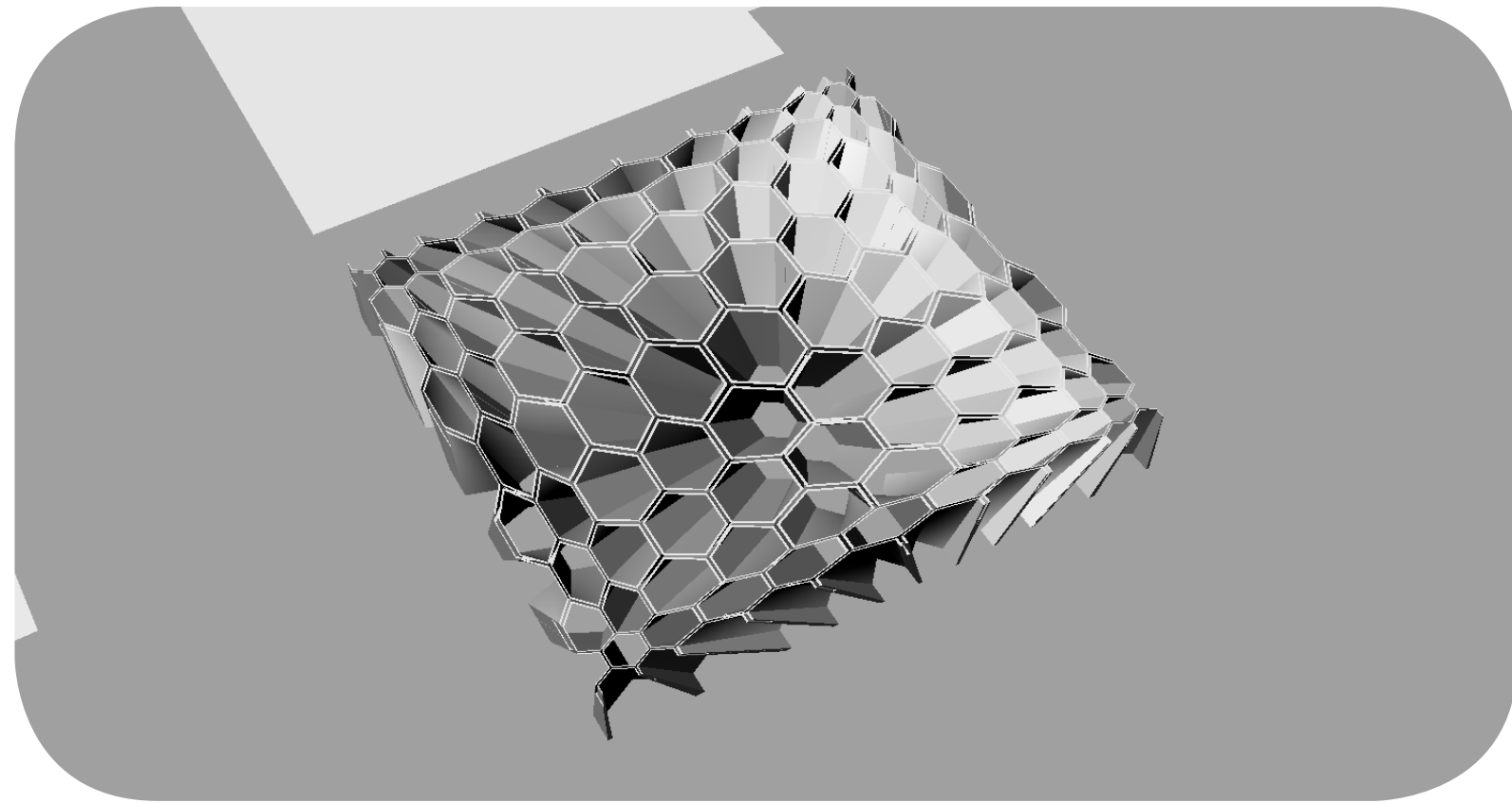
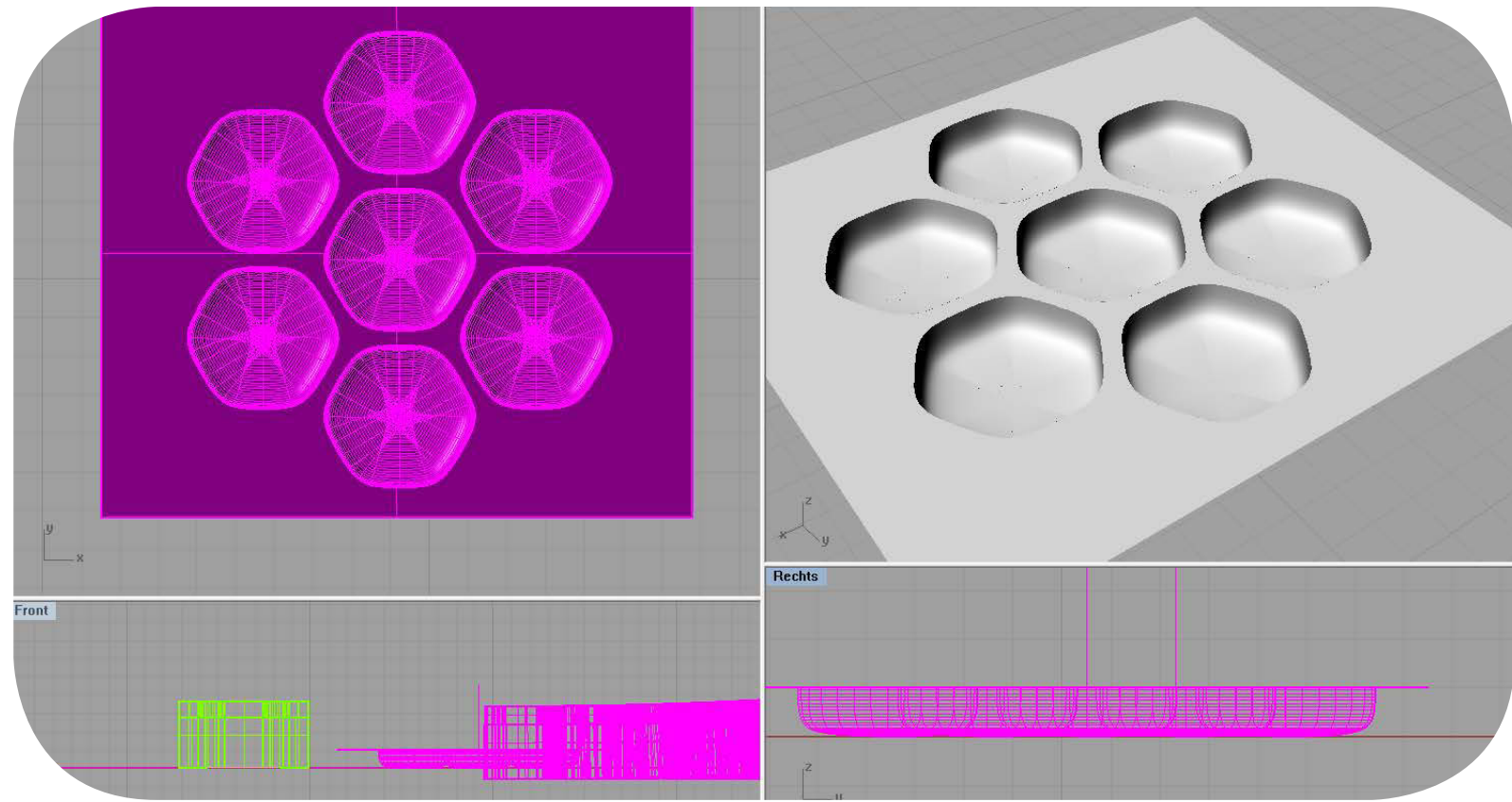
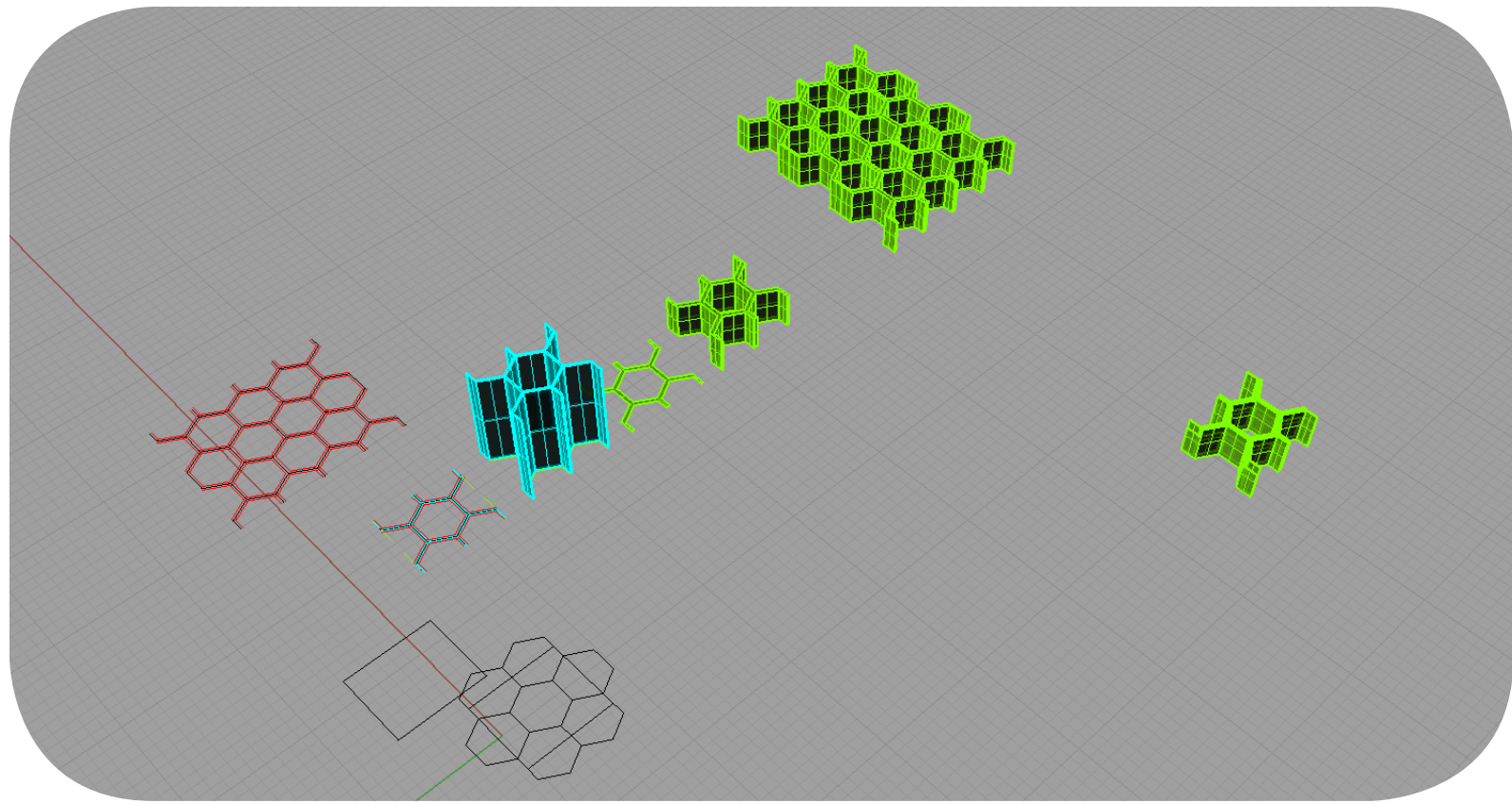



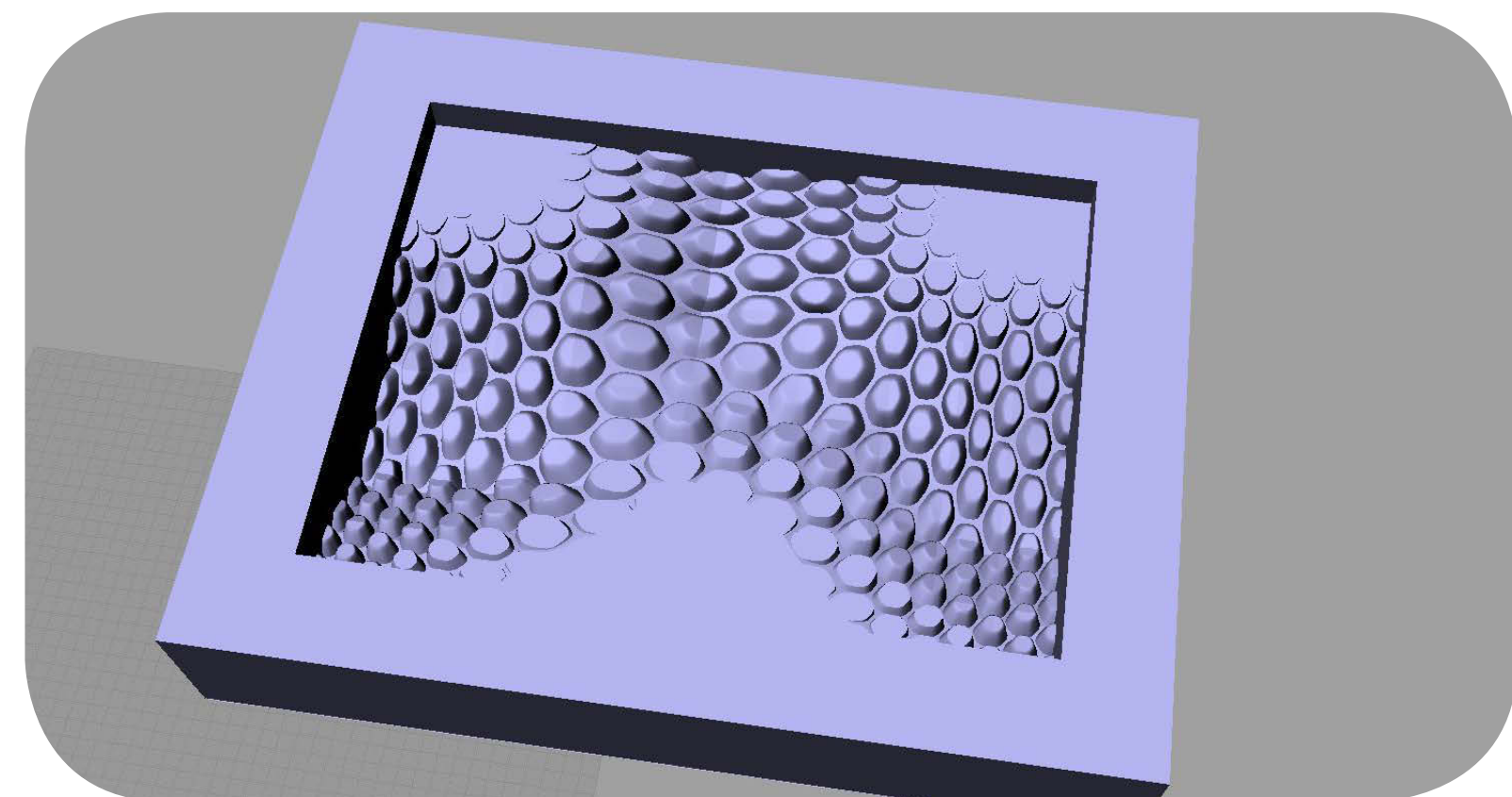
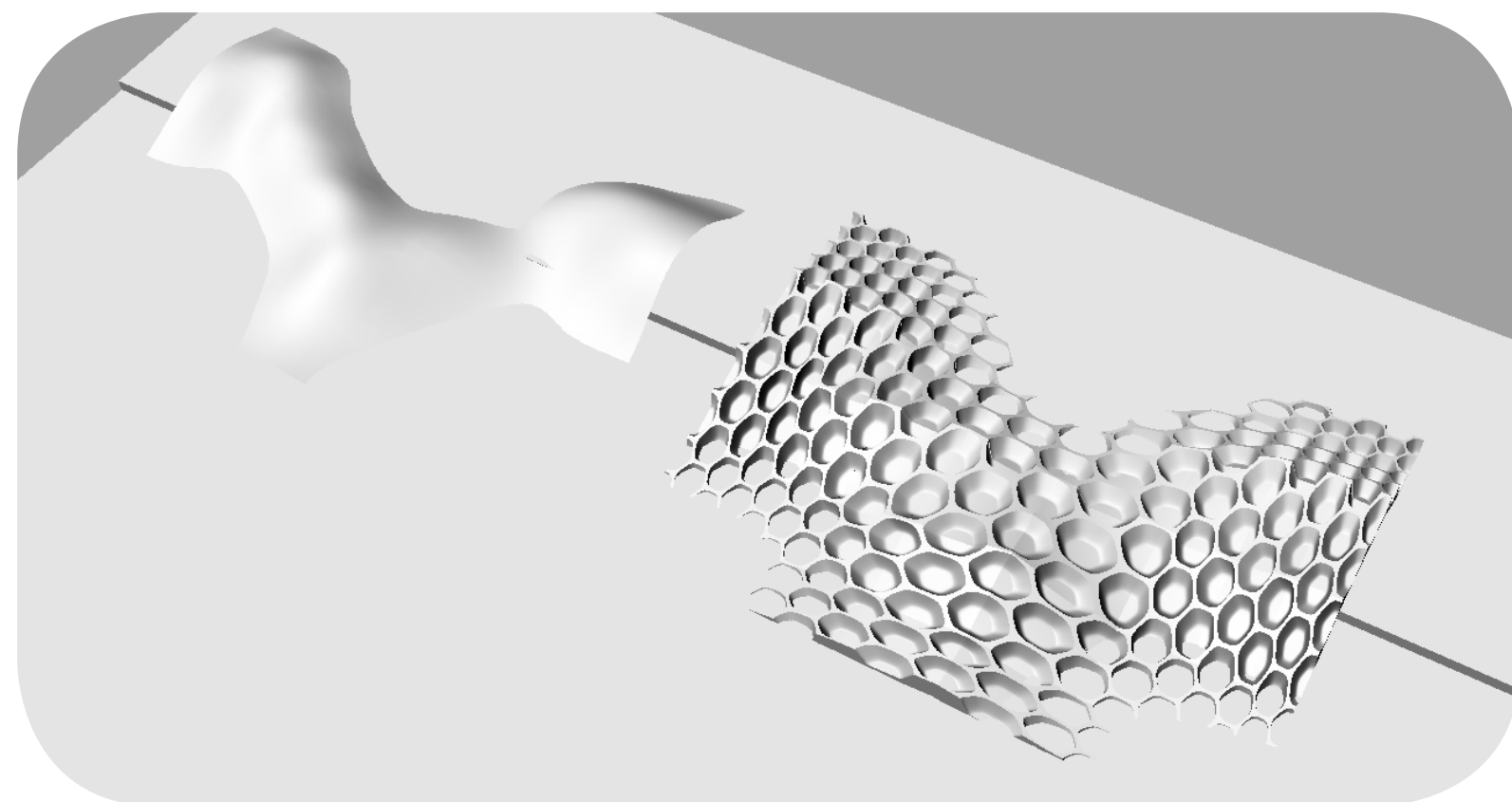
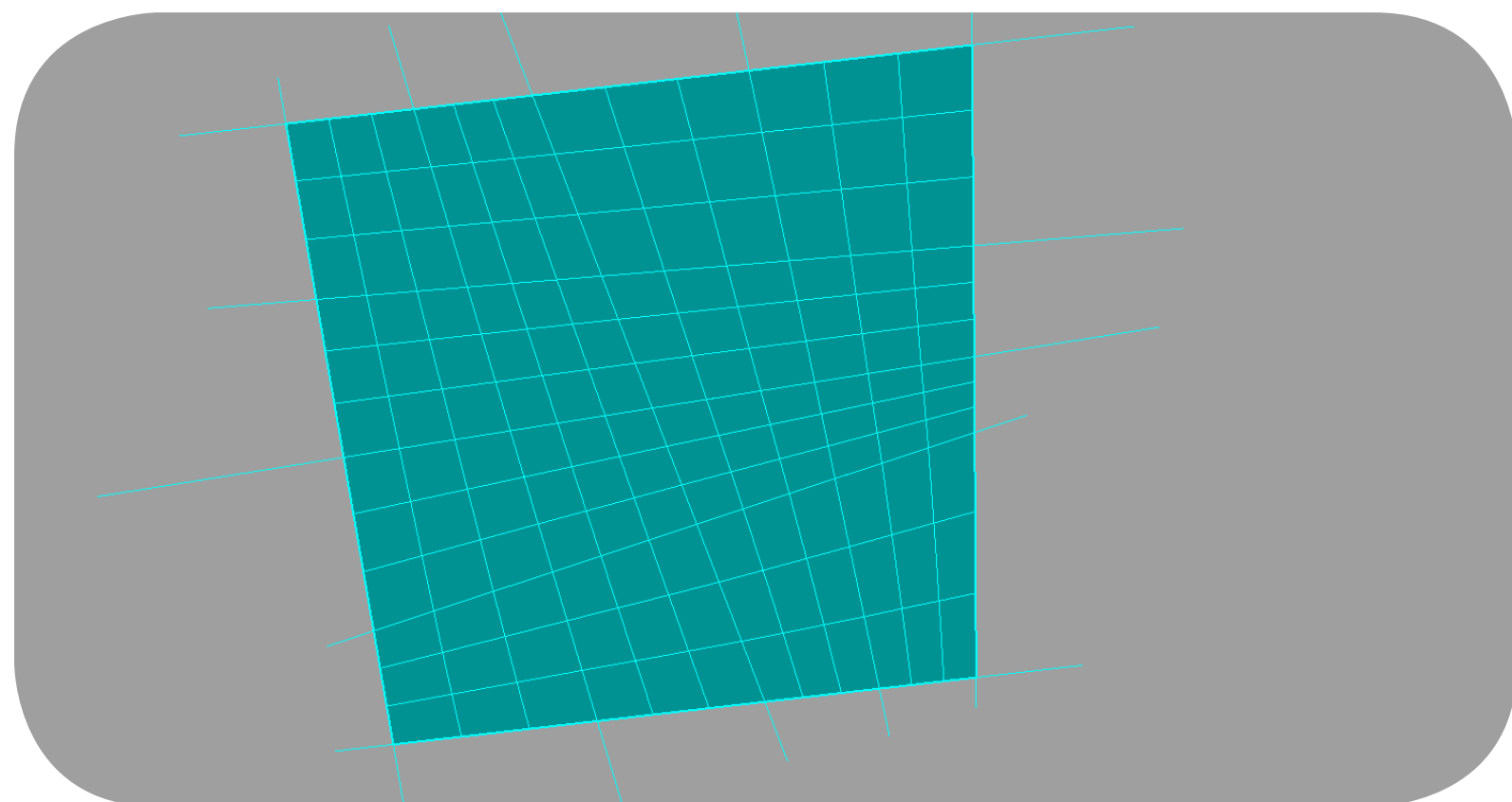
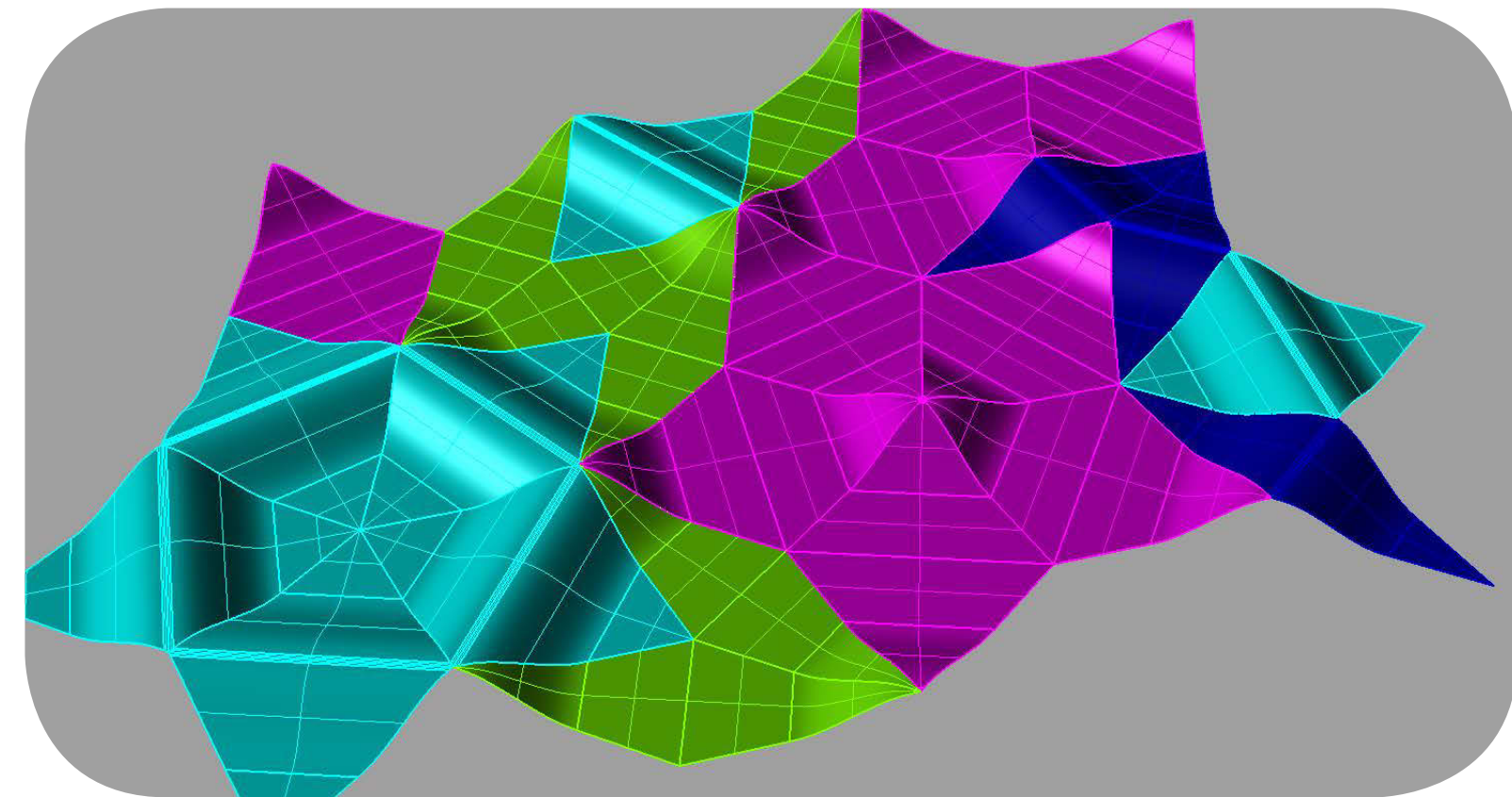
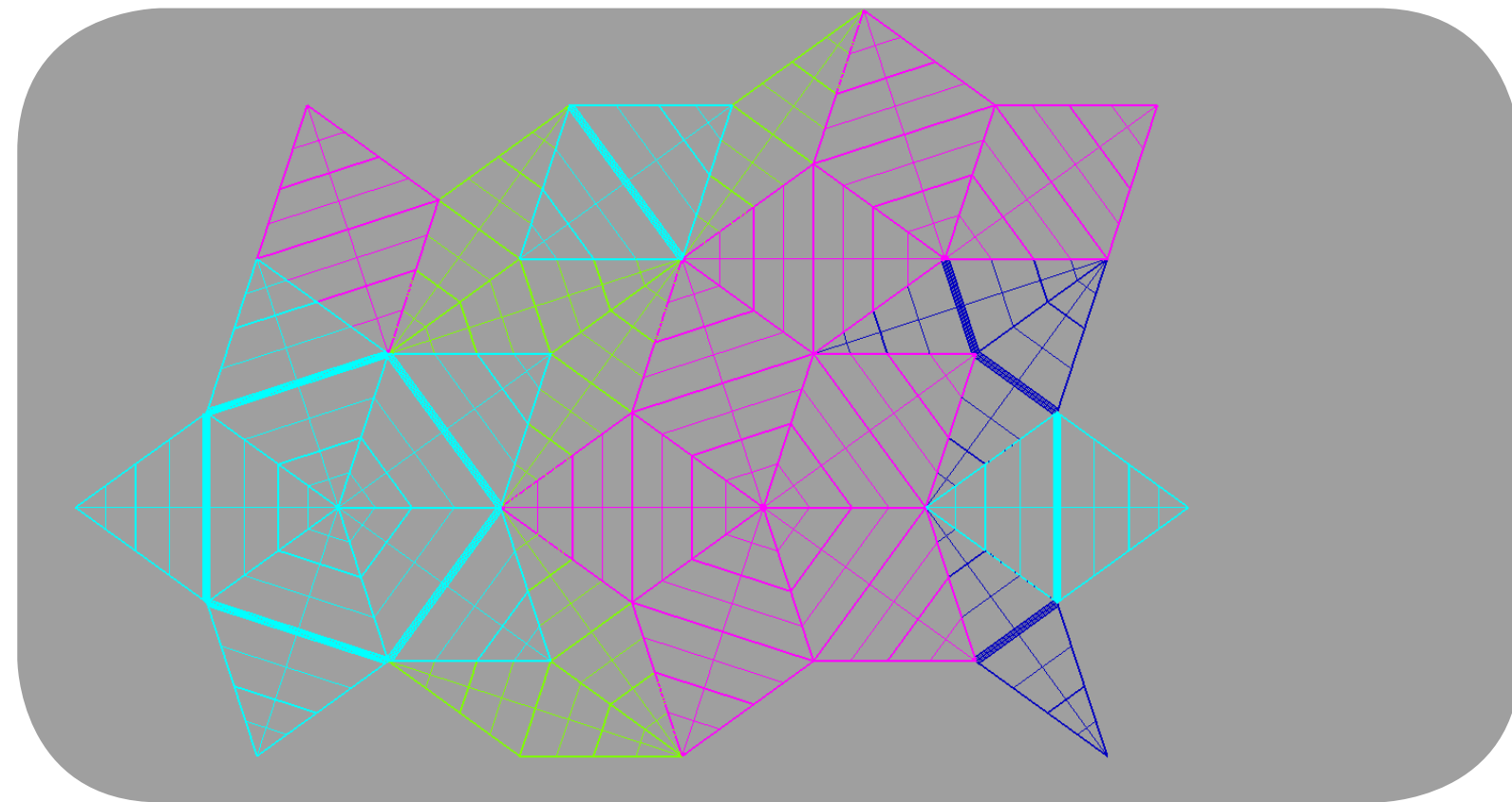
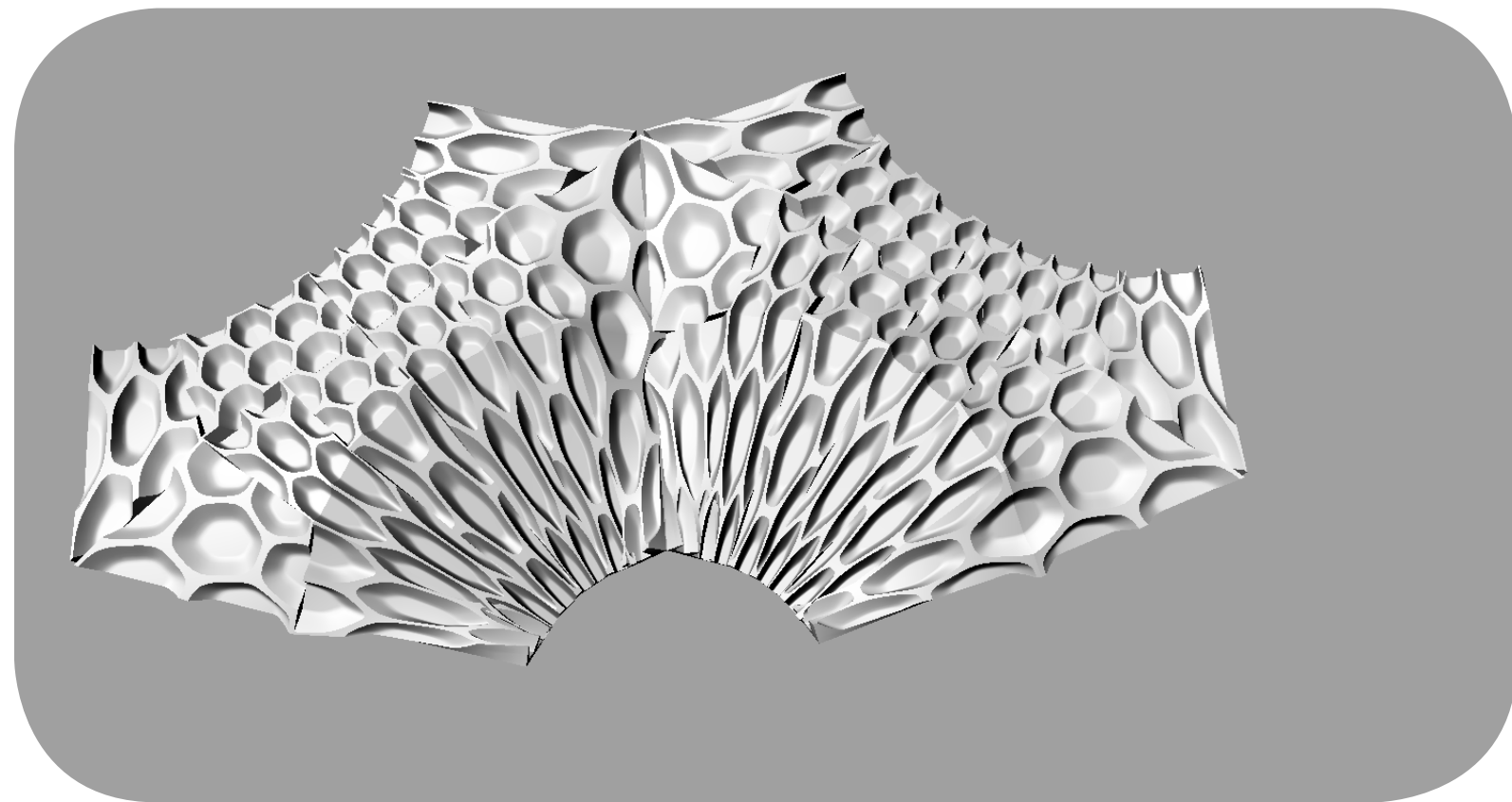
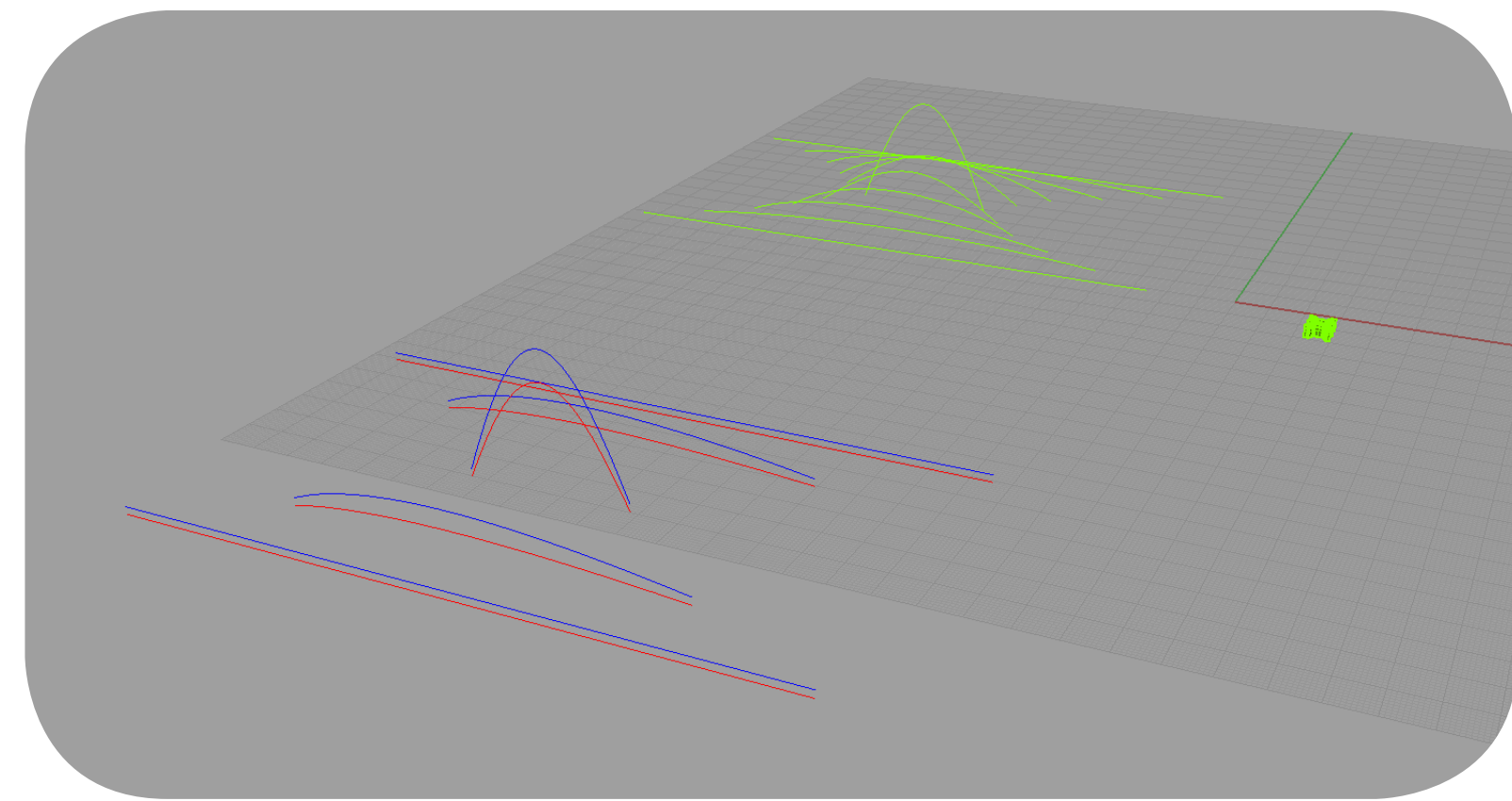
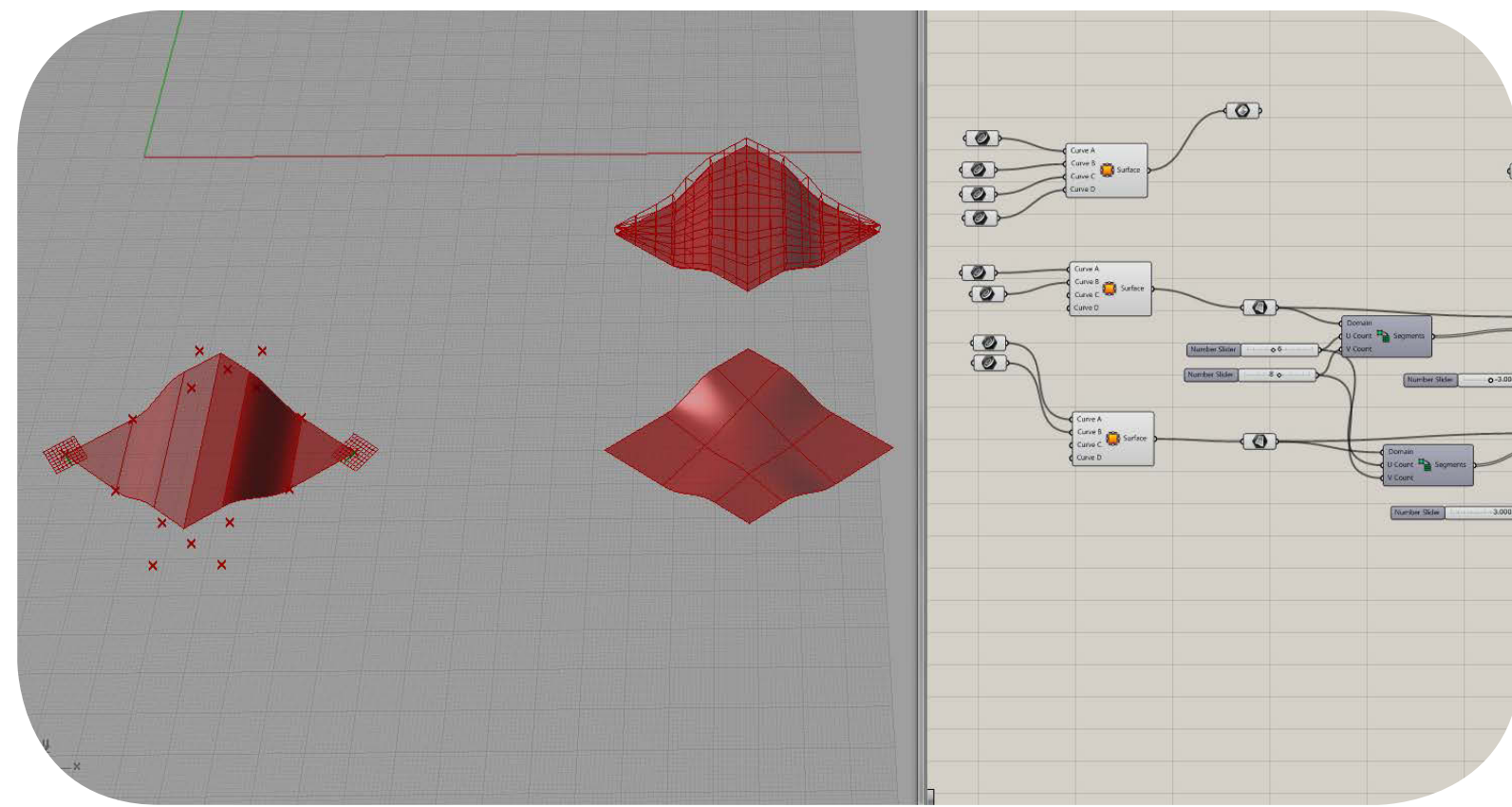
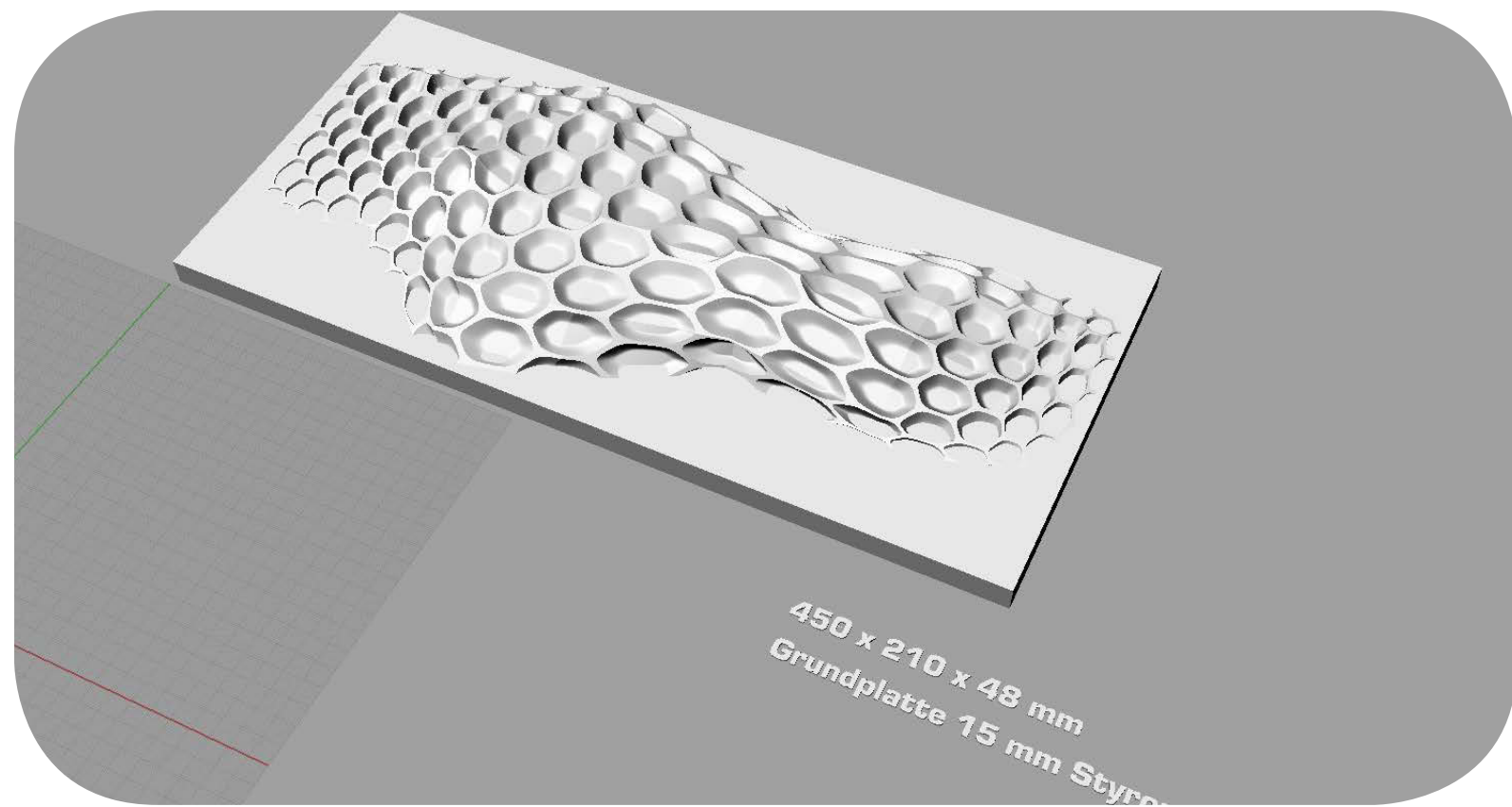



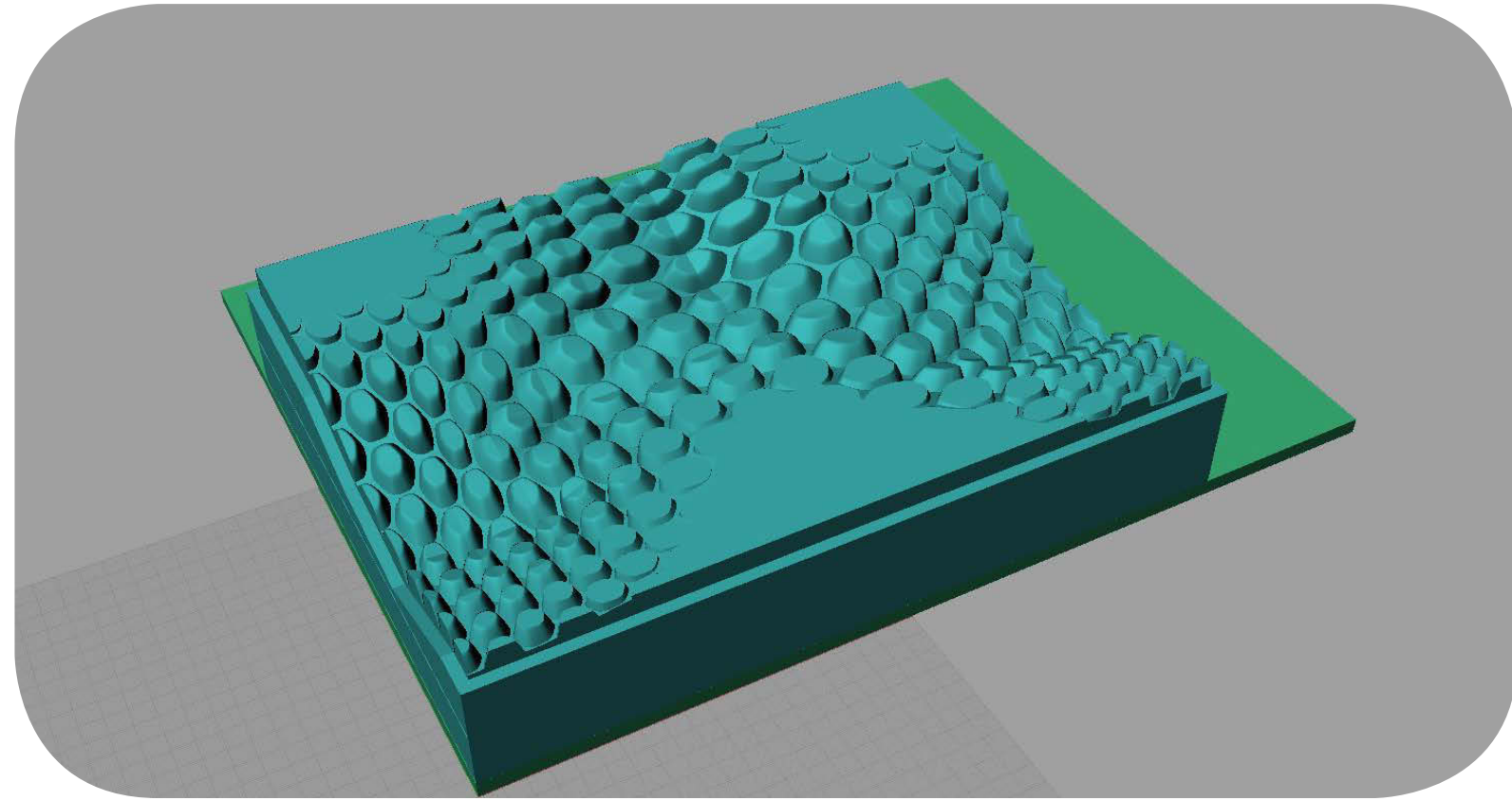
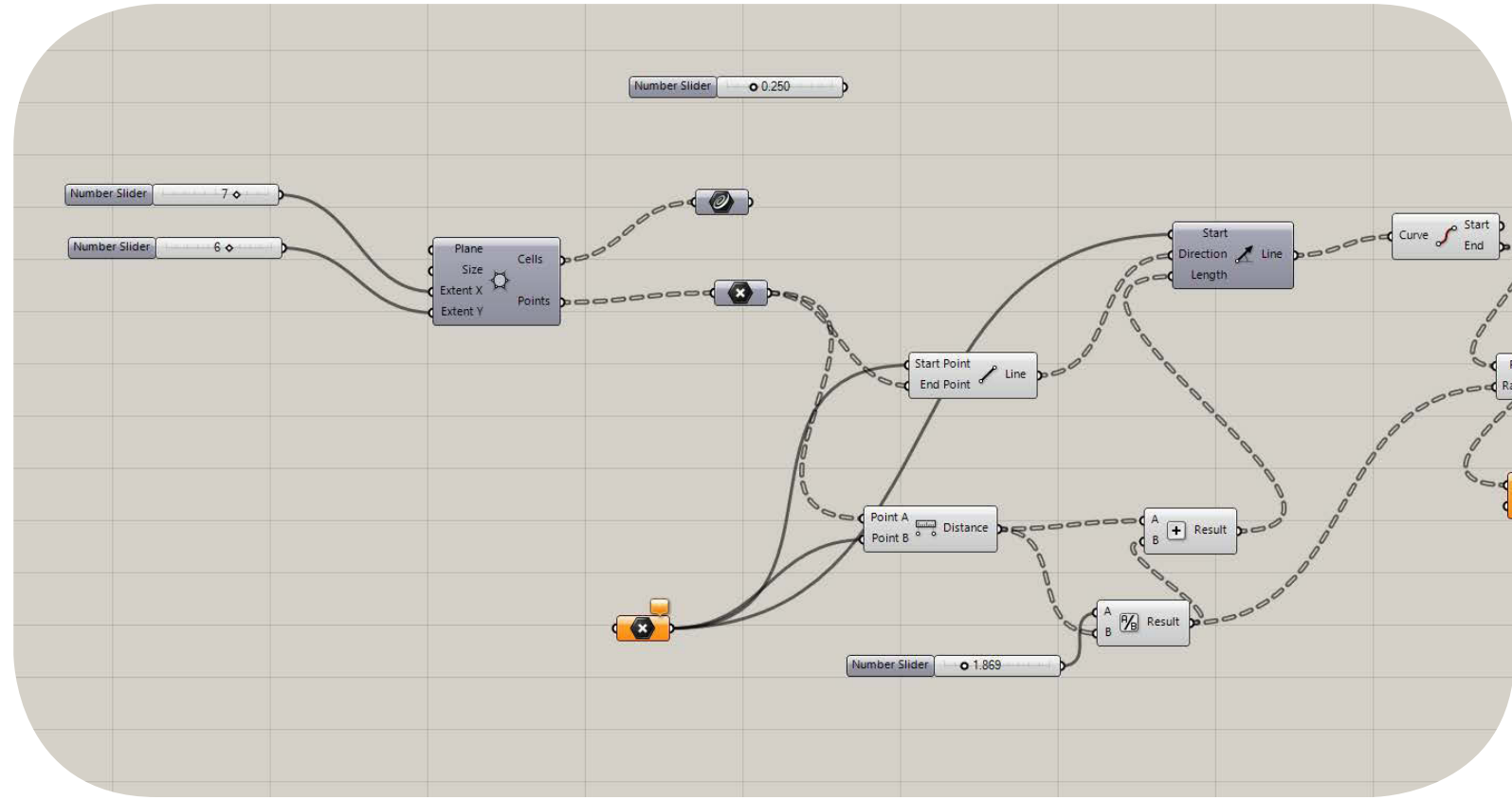
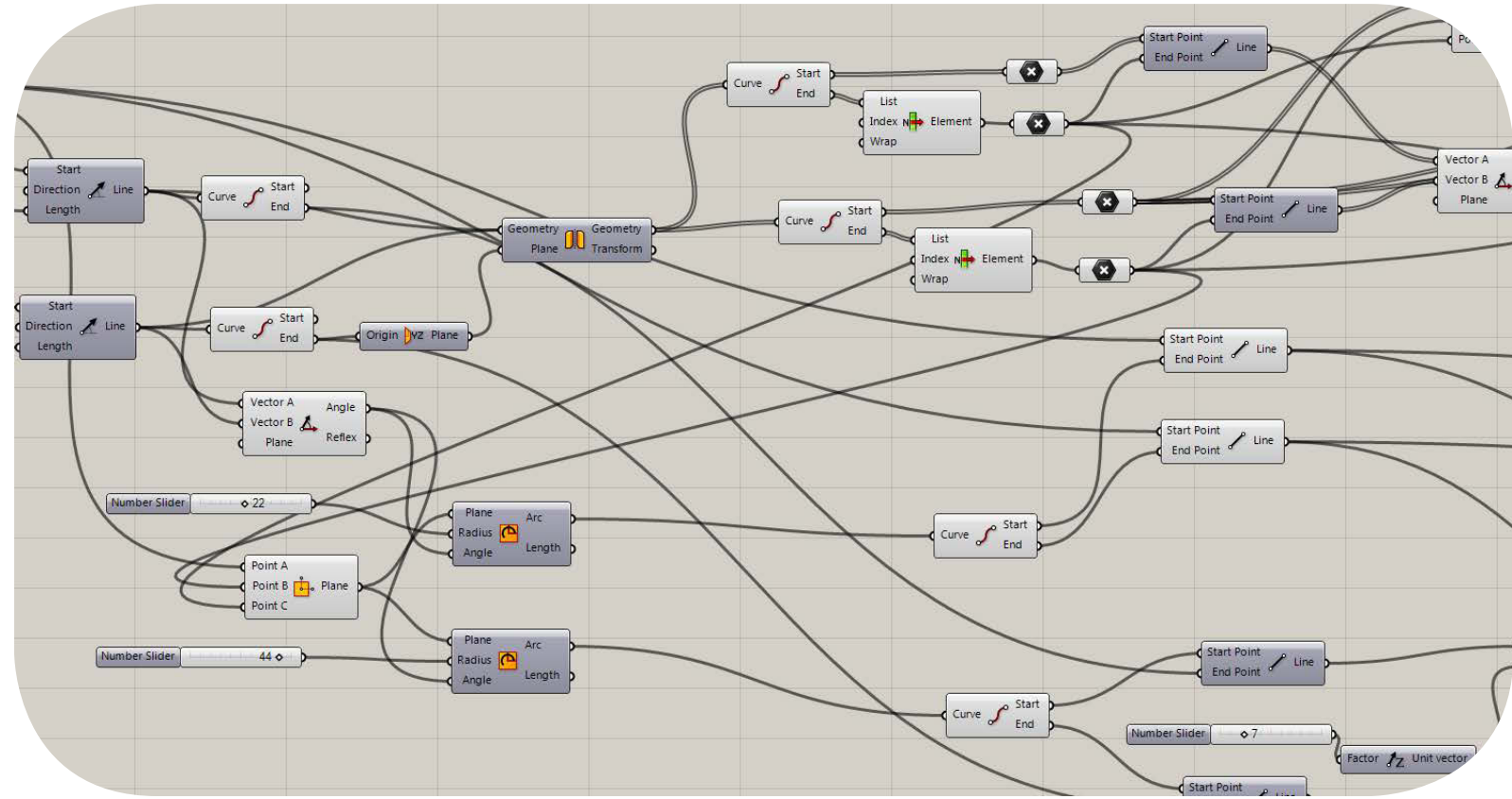
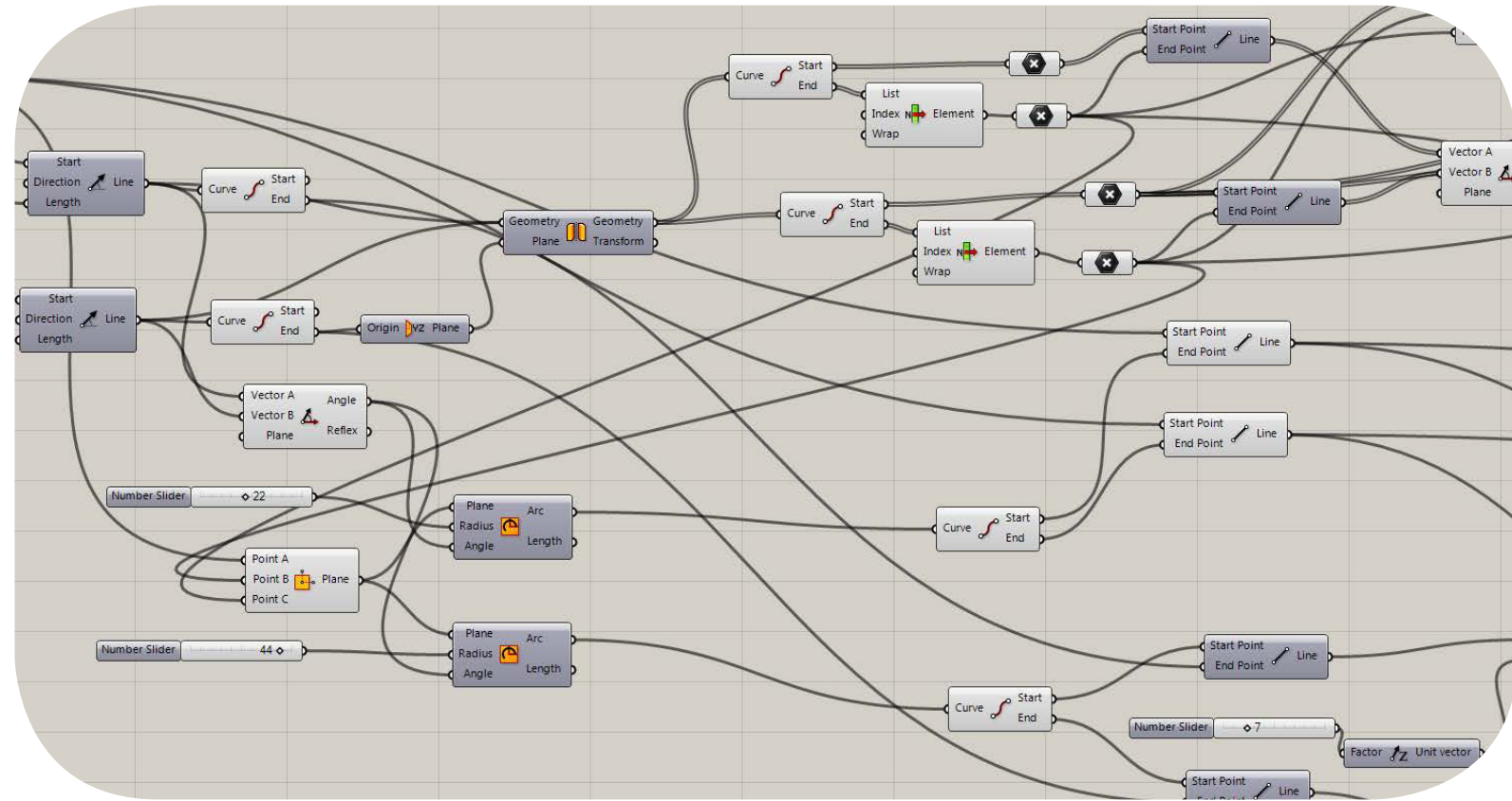
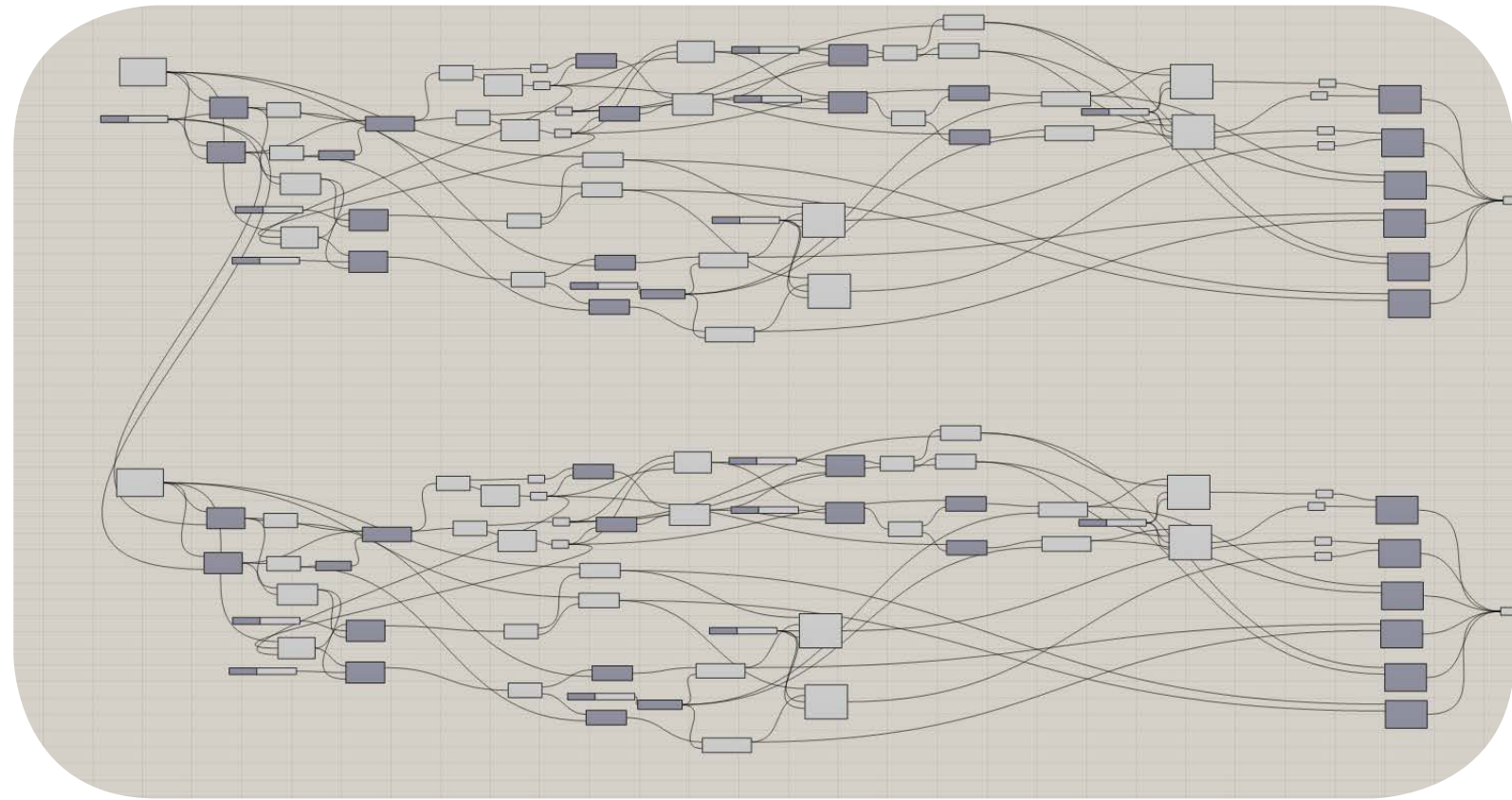
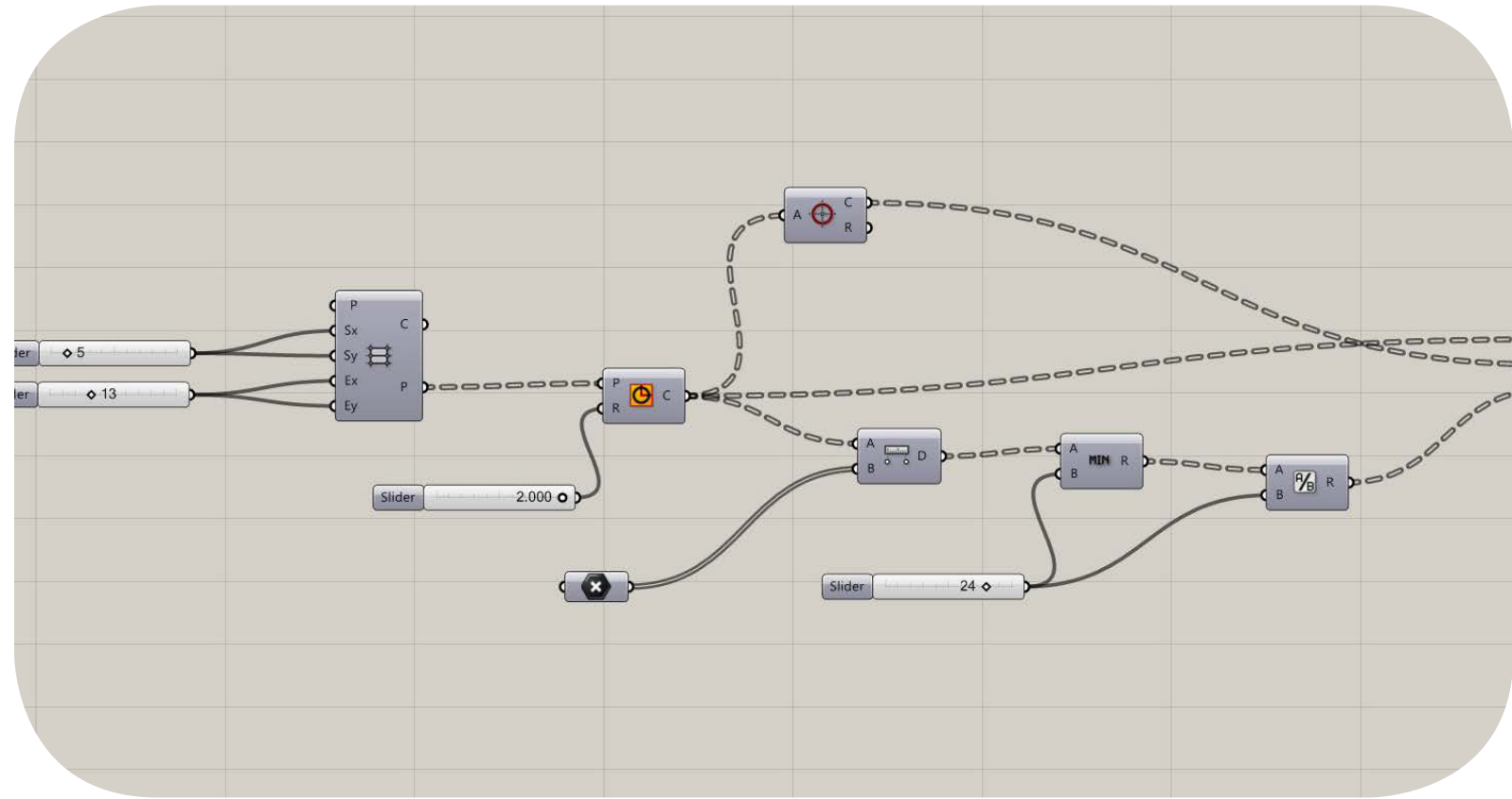
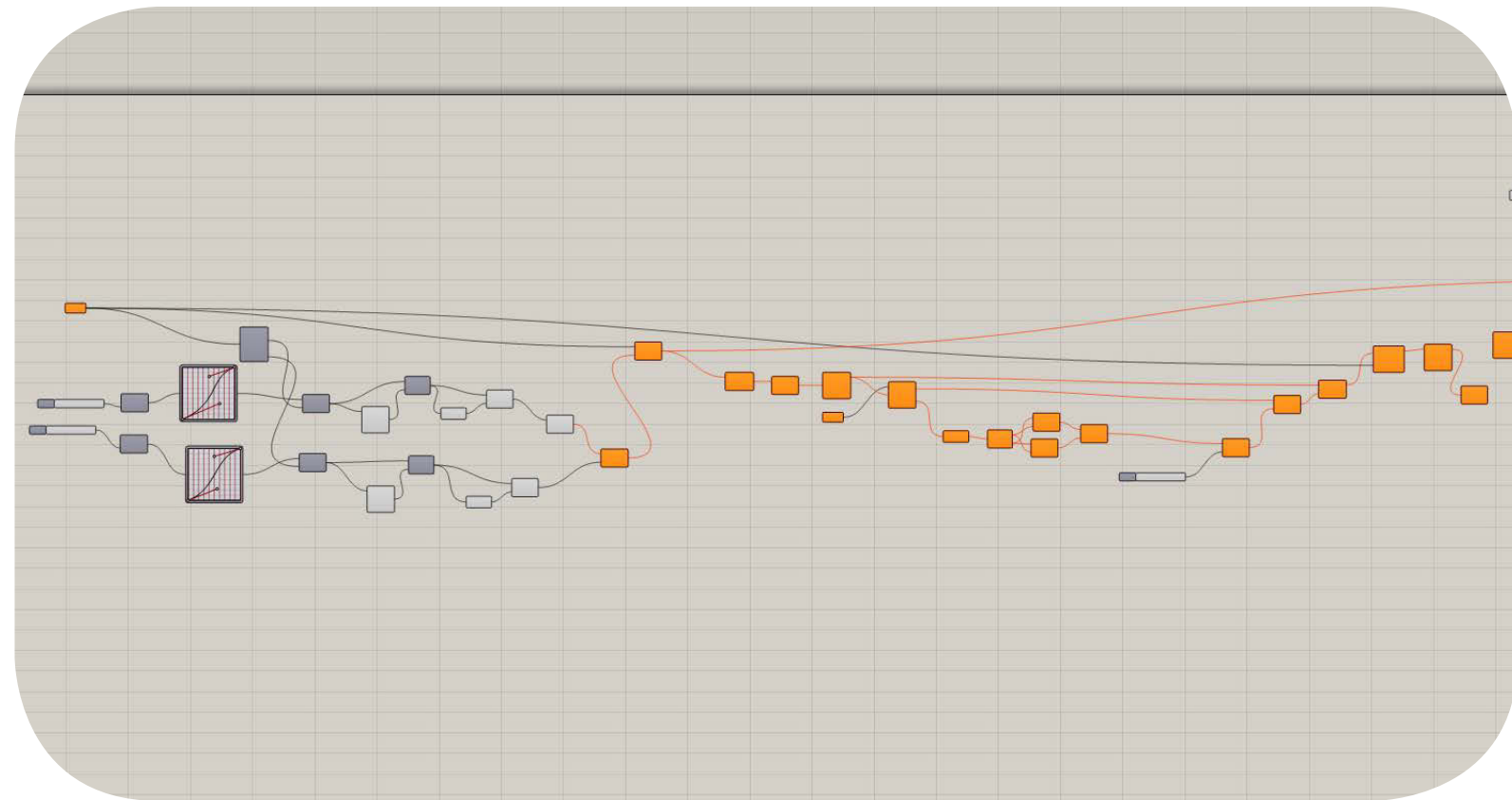
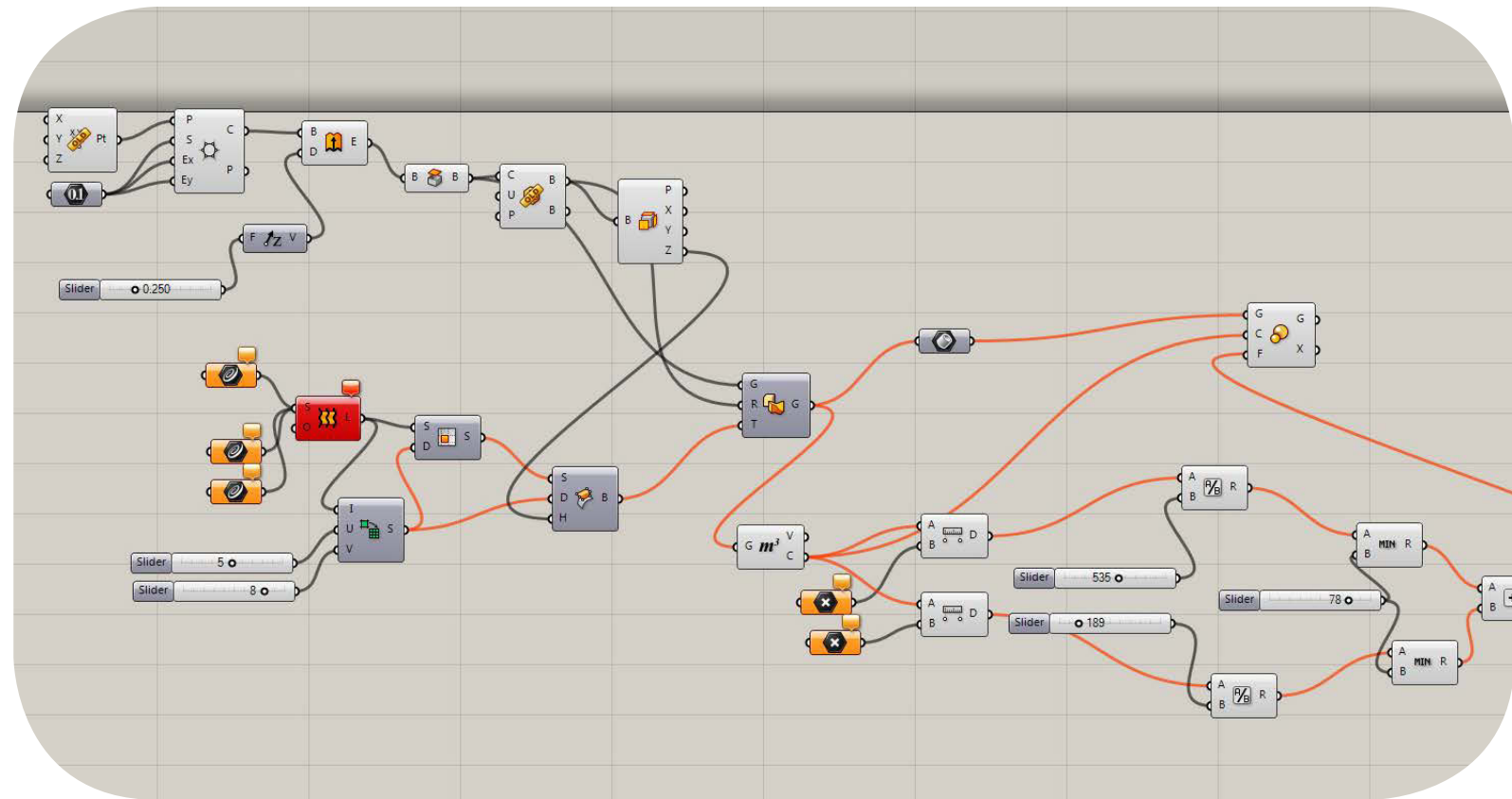
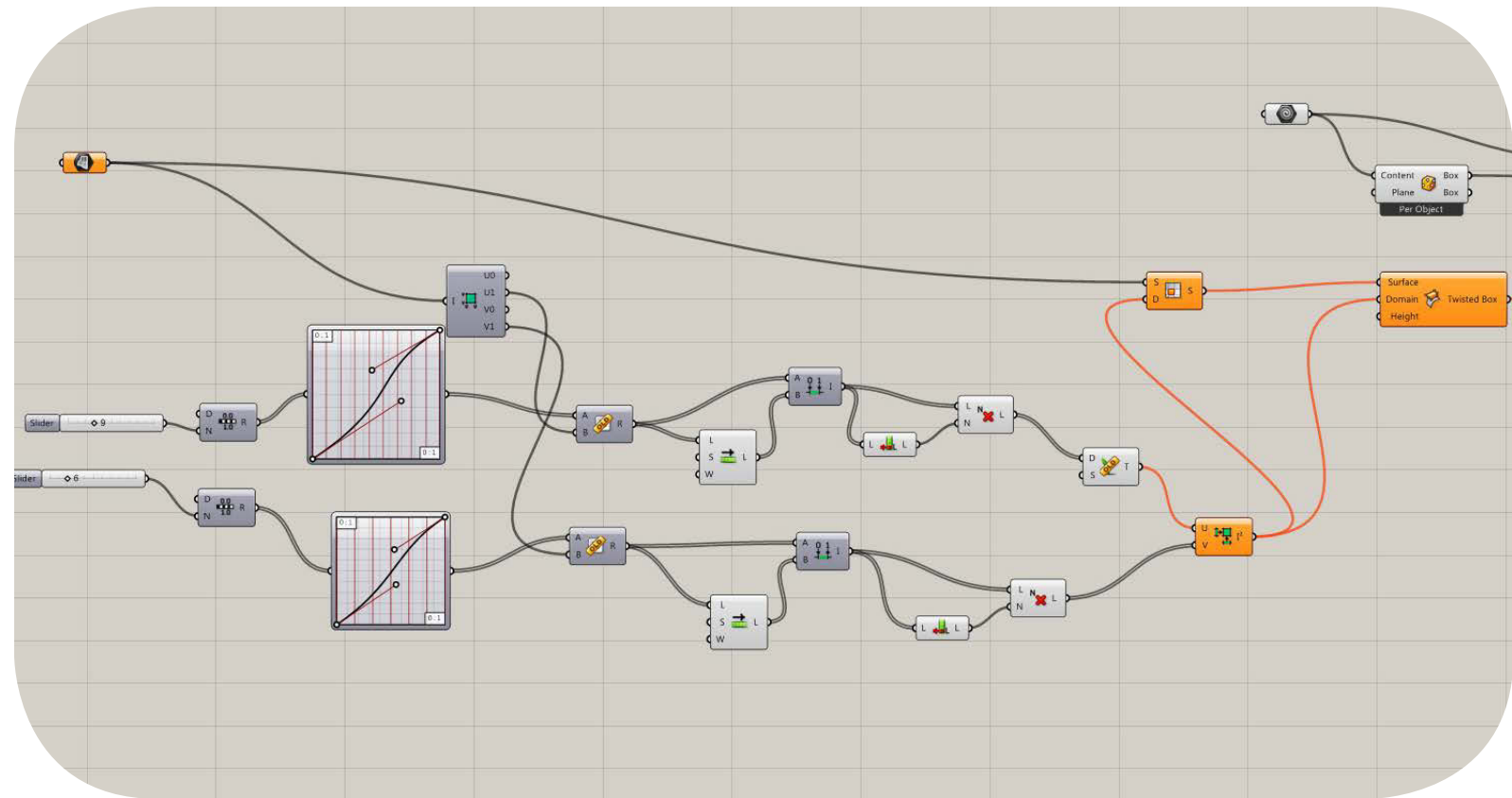



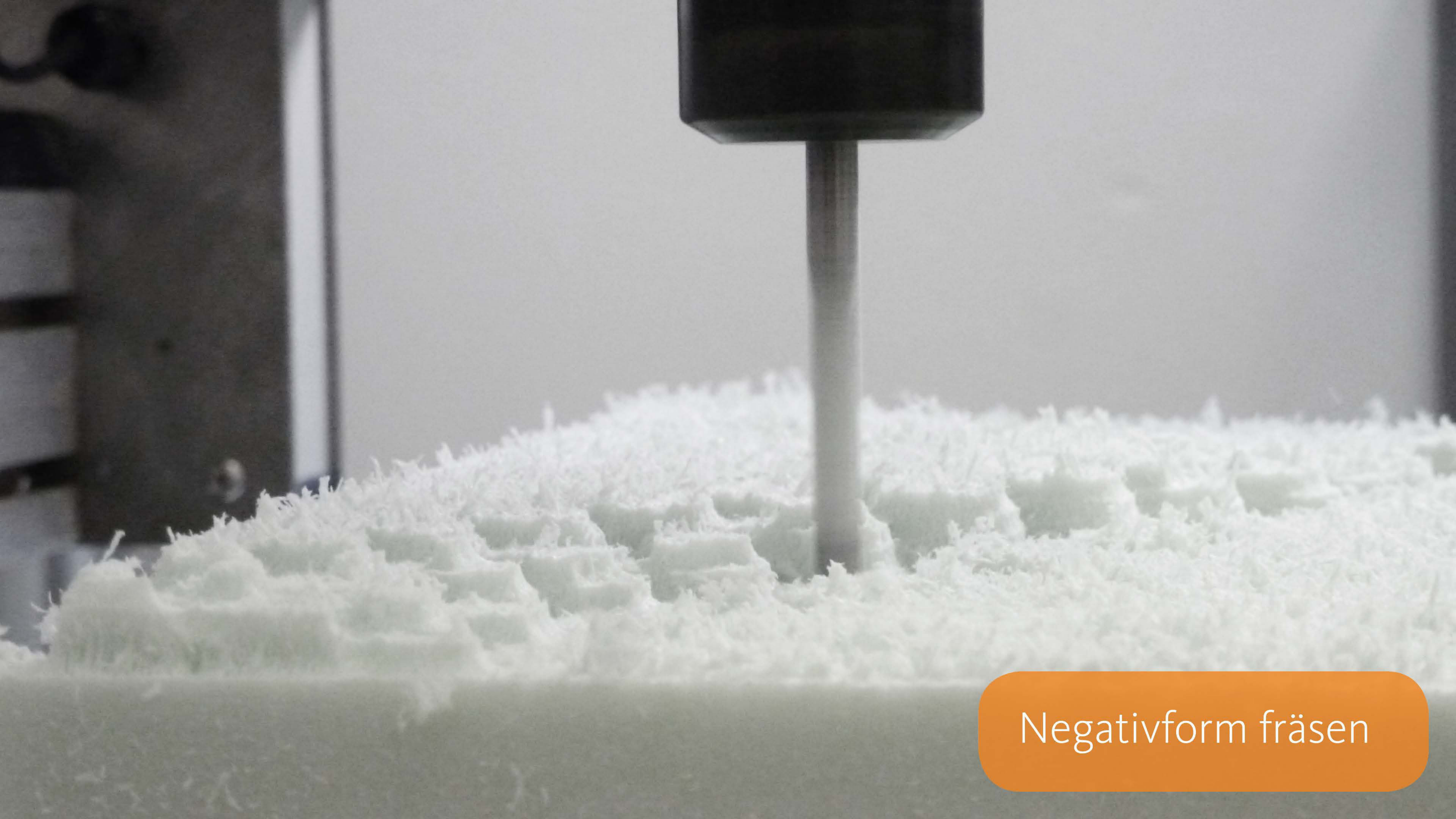

Negativform fräsen



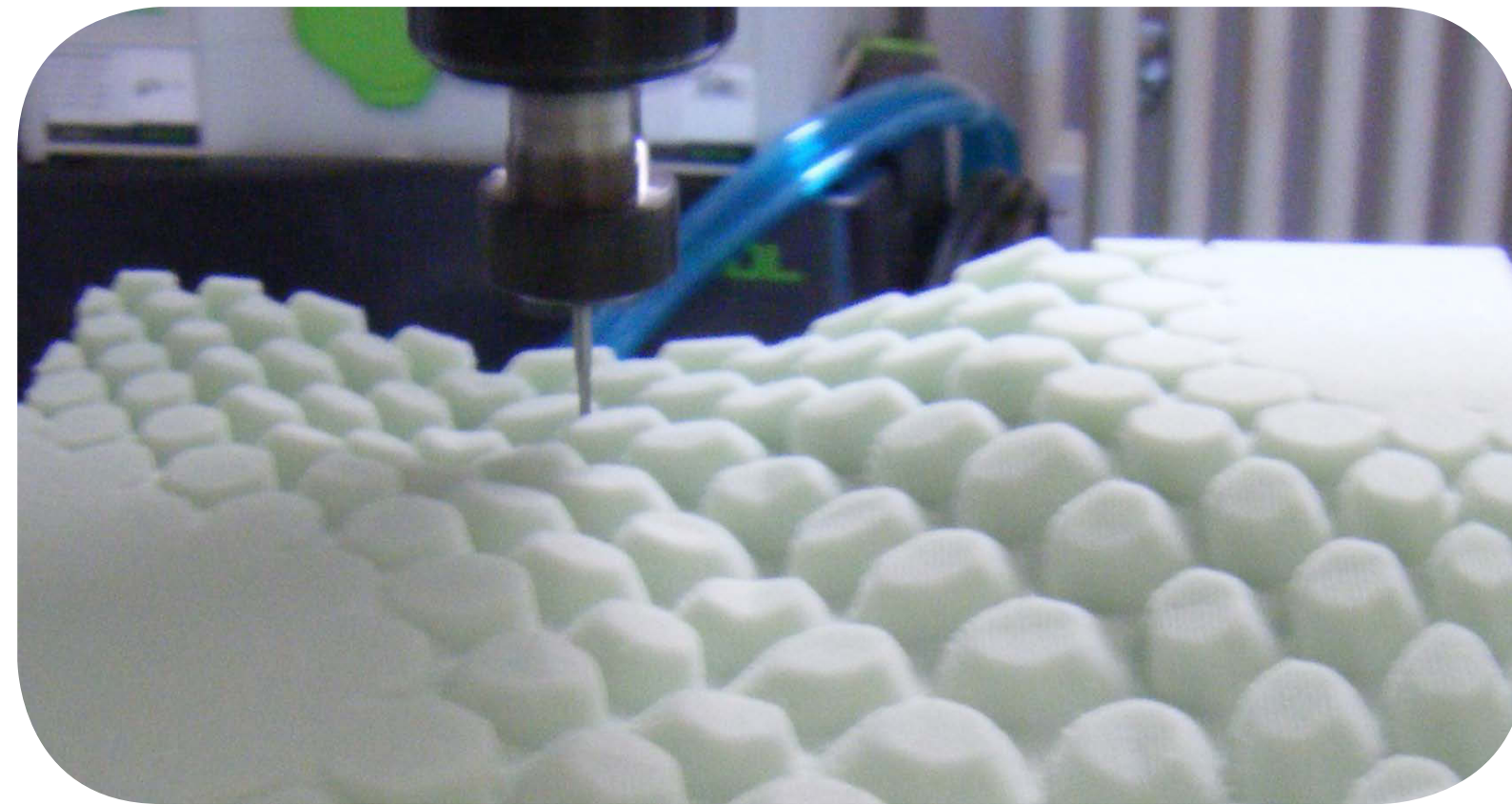
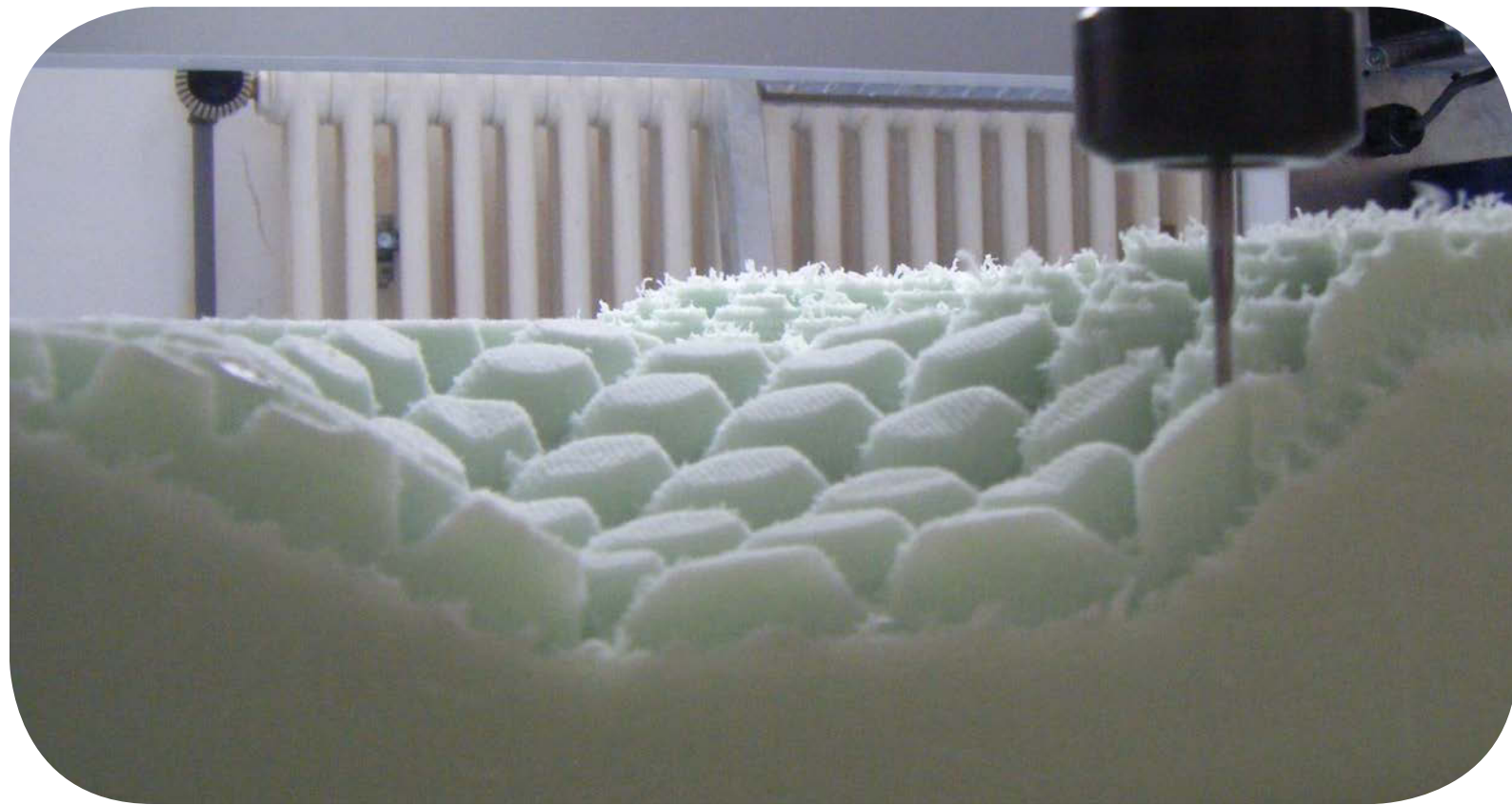
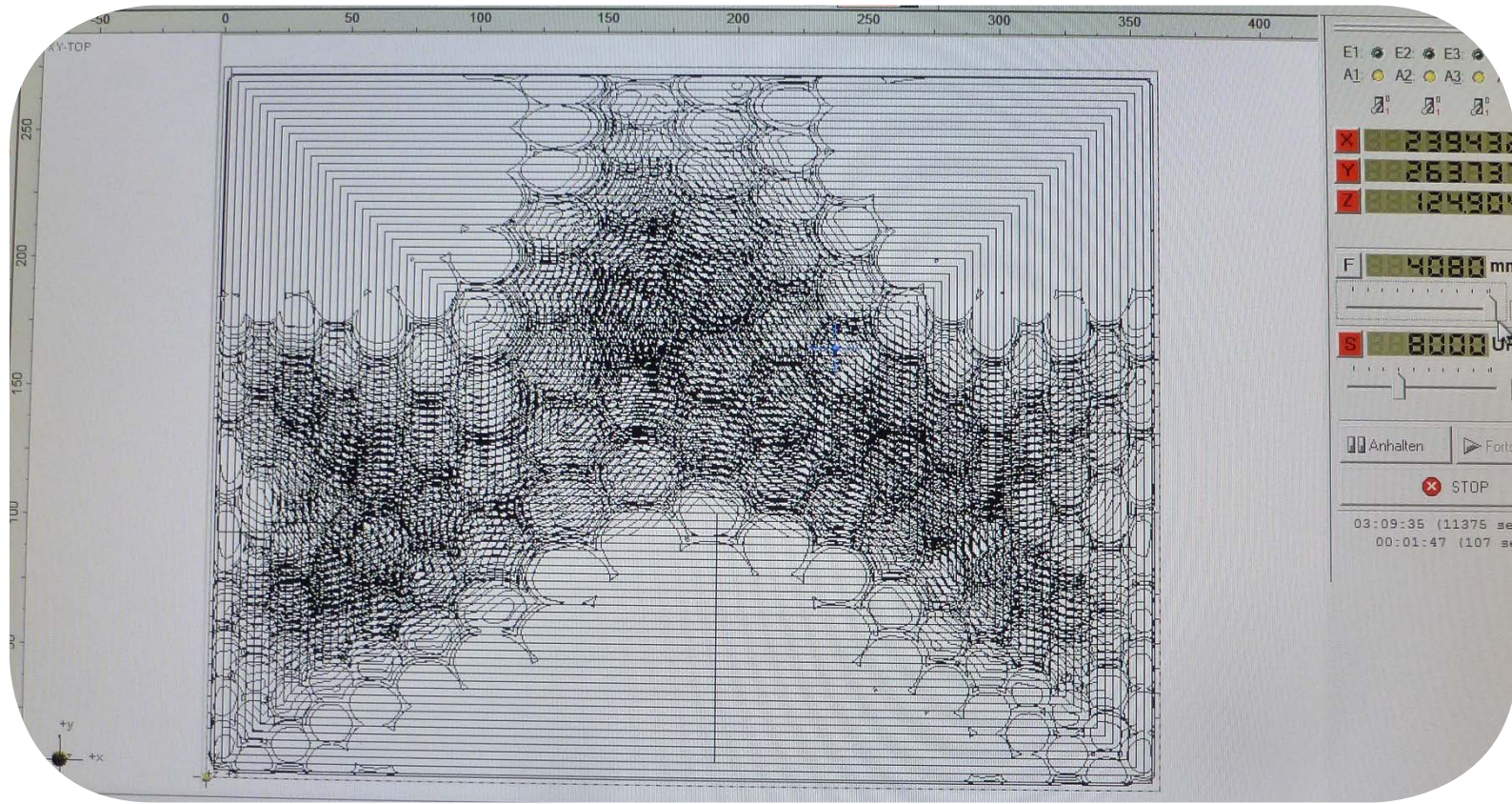
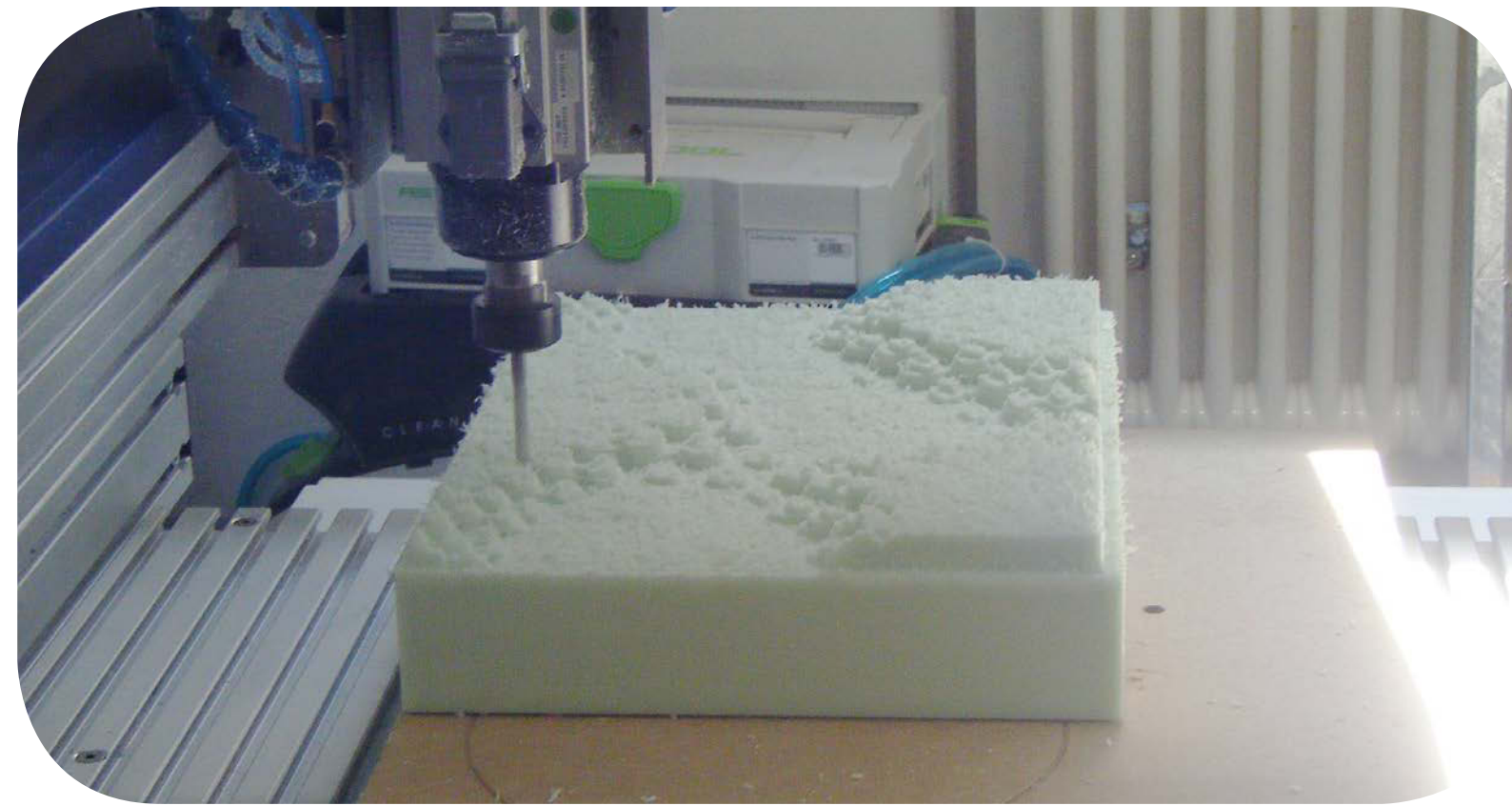





Frost vo  
Free G

Positivform gießen



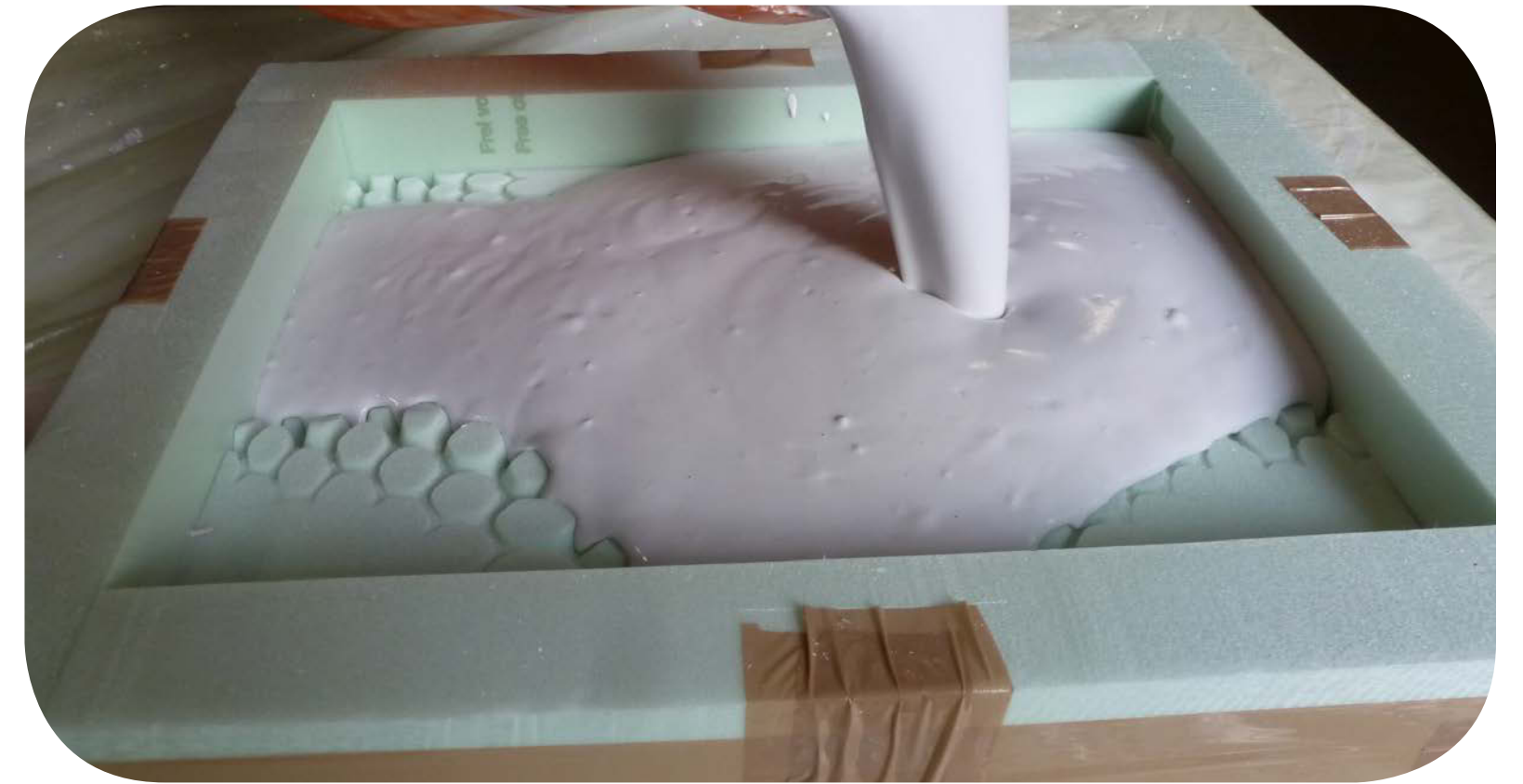
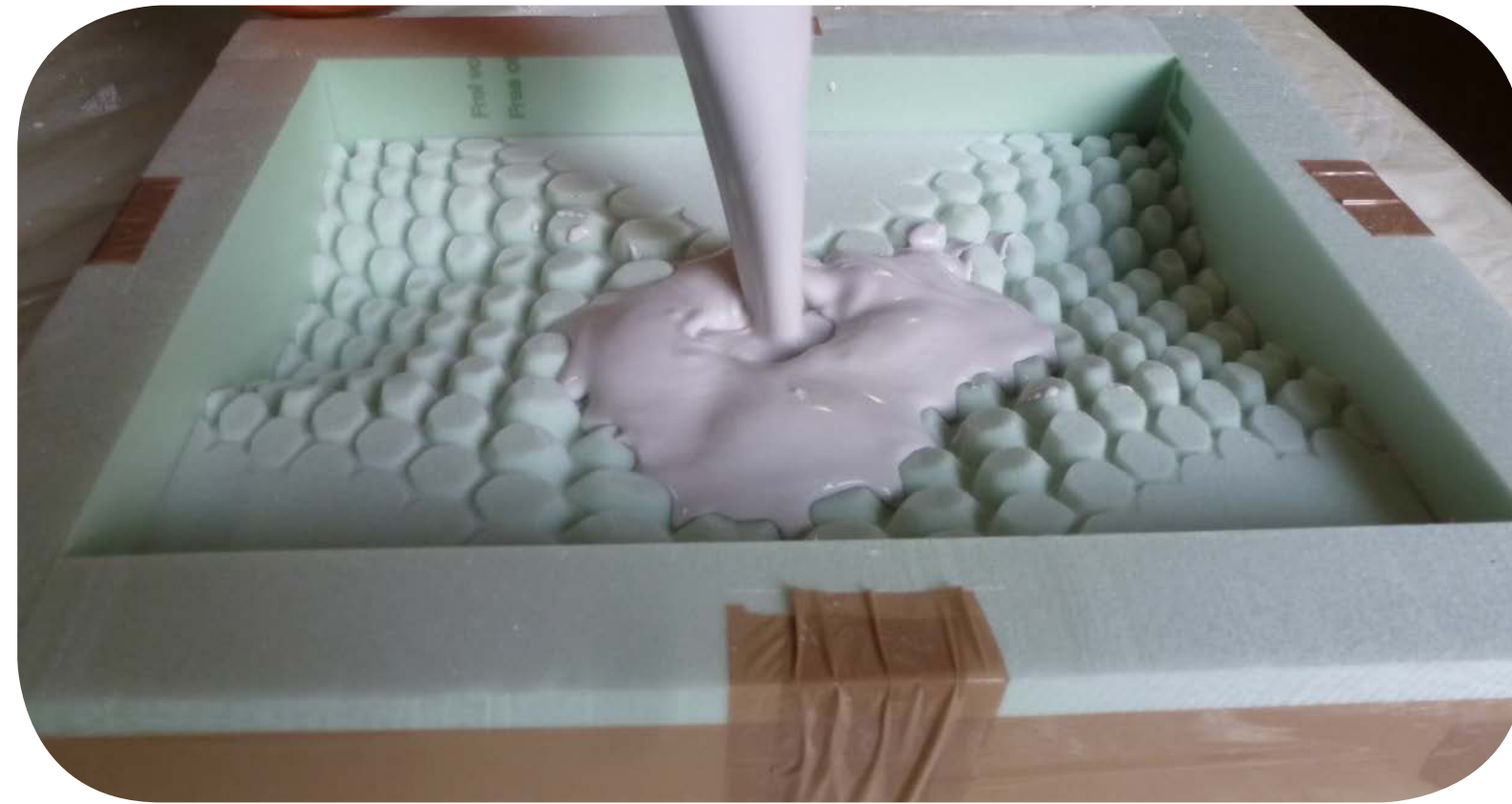
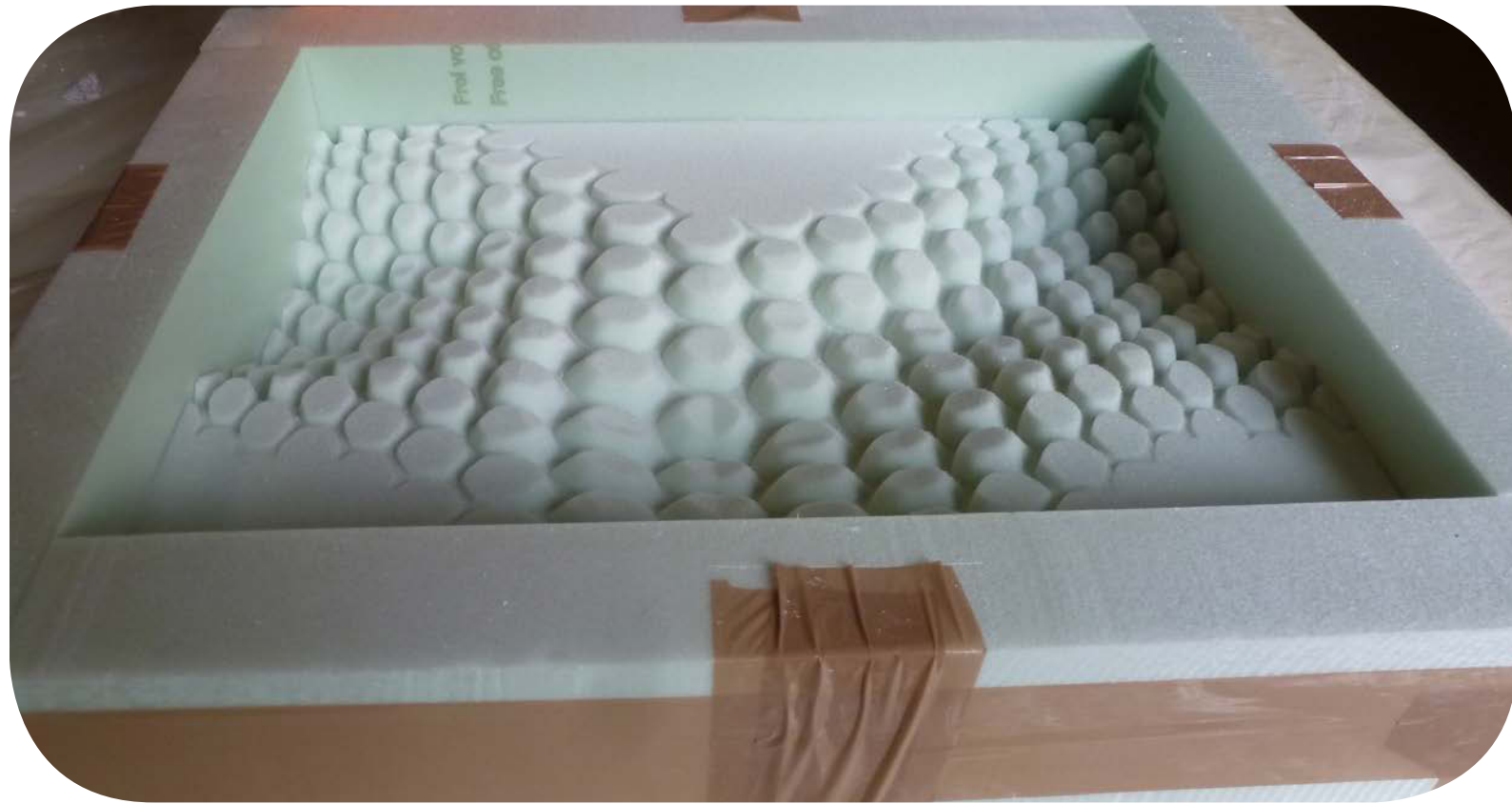
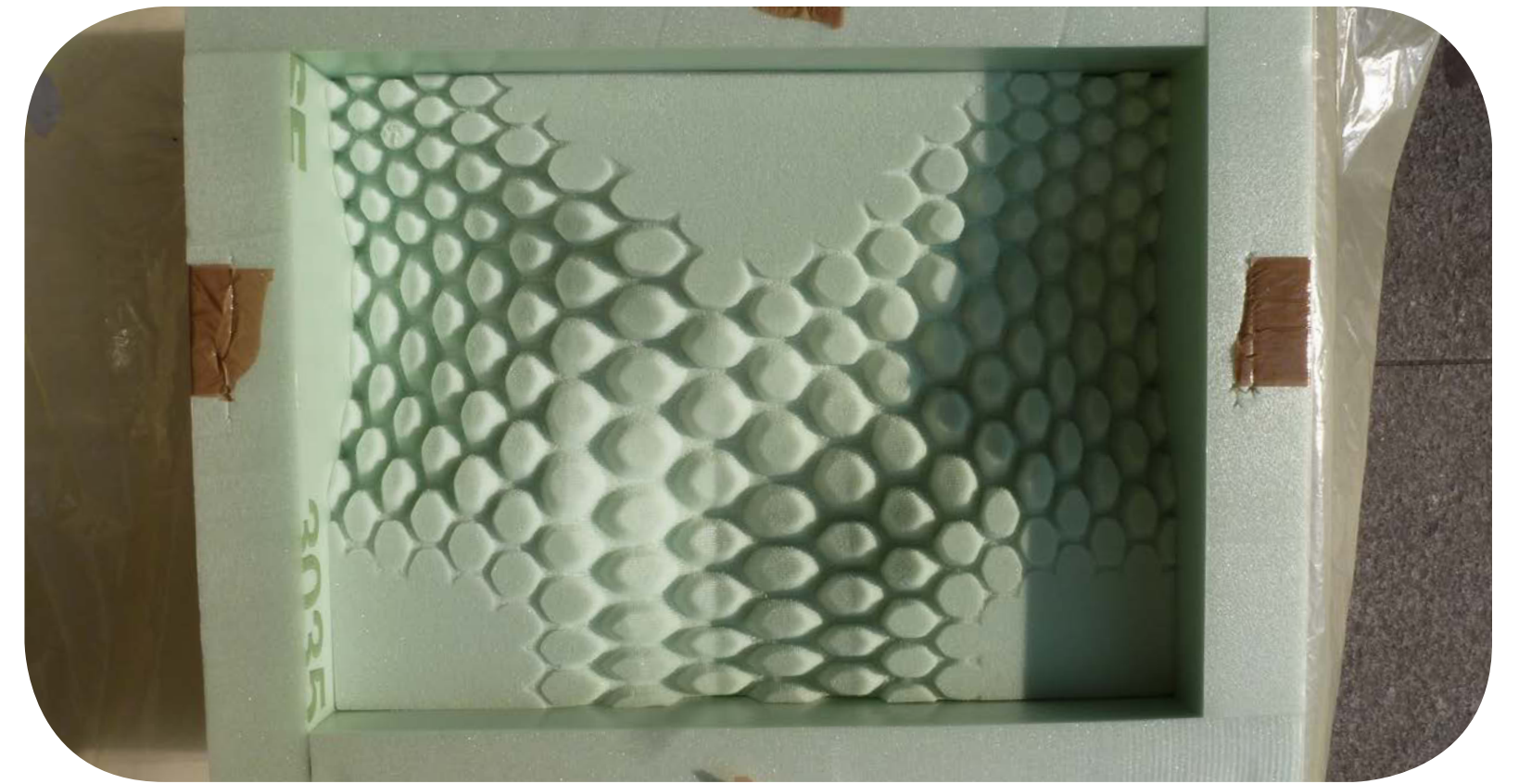



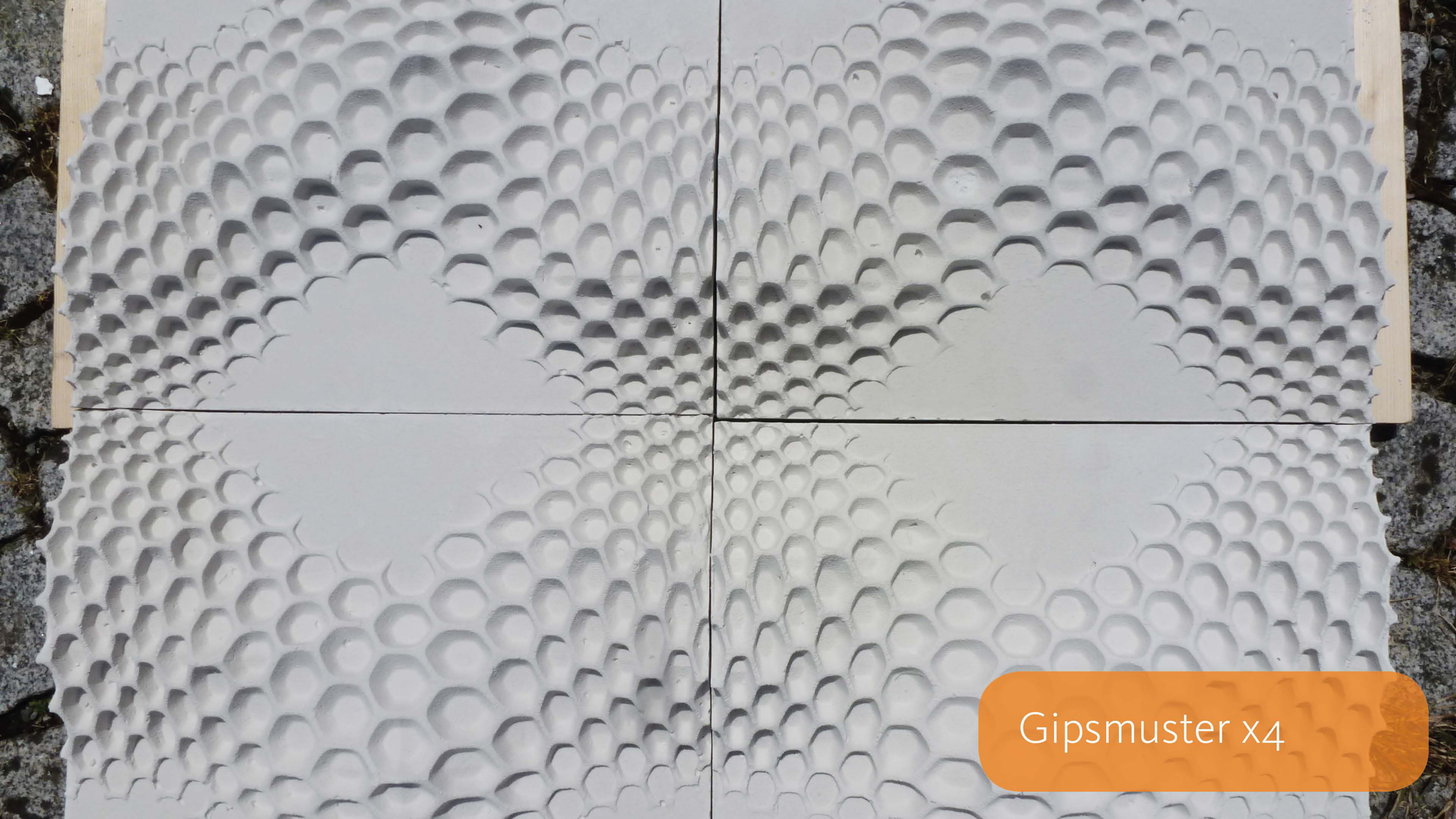

Gipsmuster x4





Einzelstück





Zukunftsperspektive